

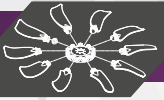

TURBO ATOMİZÖR PARÇALARI

MIST BLOWER ACCESSORIES / ACCESORIOS PARA ATOMIZADORES



AY BORU

- Turbo atomizatör fanları için ay boru
- Malzeme: 21,3x2 mm AISI 304 paslanmaz çelik
- G ½" E paso bağlantısı

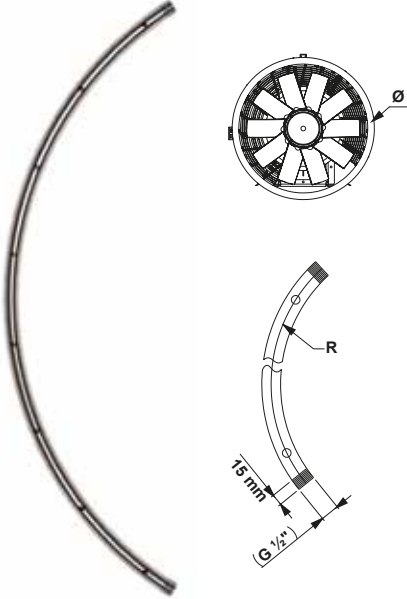

CURVED RODS

- Curved rods for orchard sprayers
- Material: 21,3x2 mm AISI 304 stainless steel
- G ½" M threaded fitting

BARRAS CURVAS

- Barras curvas para atomizadores
- Material: 21,3x2 mm AISI 304 de acero
- G ½" M toma roscada

TAKIM PAIR - PAR	KOD Code - Código	FAN Ø (mm)	R (mm)	DELİK SAYISI Holes Orificios	DELİK ÇAPI Ø
08001565	08001565LR	600	345	5	7
08001566	08001566LR			6	
08001575	08001575LR	700	395	5	
08001576	08001576LR			6	
08001577	08001577LR			7	
08001586	08001586LR	800	445	6	
08001587	08001587LR			7	
08001588	08001588LR			8	
08001596	08001596LR	900	495	6	
08001597	08001597LR			7	
08001598	08001598LR			8	
080015107	080015107LR	1000	545	7	
080015108	080015108LR			8	
080015109	080015109LR			9	

KELEPÇELİ AY BORU

- Turbo atomizatör fanları için kelepçeli ay boru
- Malzeme: 21,3x2 mm AISI 304 paslanmaz çelik
- G ½" E paso bağlantısı (Bir tarafı piriç kör tapalı)
- G ¼" Dişi meme kelepçeleri dahildir



CURVED RODS WITH NOZZLE HOLDER CLAMPS

- Curved rods with nozzle holder clamps for orchard sprayers
- Material: 21,3x2 mm AISI 304 stainless steel
- G ½" M threaded fitting (With blanking cap by one side)
- G ¼" F Nozzle holders clamps are included

BARRAS CURVAS CON ABRAZADERA DE PORTABOQUILLAS

- Barras curvas con abrazadera de portaboquillas para atomizadores
- Material: 21,3x2 mm AISI 304 de acero
- G ½" M toma roscada (Con tapón hembra por una parte)
- G ¼" H abrazaderas de portaboquillas están incluidas

TAKIM PAIR - PAR	SOL Left - Izquierda	SAĞ Right - Derecha	FAN Ø (mm)	R (mm)	MEME SAYISI Nozzles Boquillas	G
080016165	080016165L	080016165R	600	345	5	G ¼"
080016166	080016166L	080016166R			6	
080016175	080016175L	080016175R	700	395	5	
080016176	080016176L	080016176R			6	
080016177	080016177L	080016177R			7	
080016186	080016186L	080016186R	800	445	6	
080016187	080016187L	080016187R			7	
080016188	080016188L	080016188R			8	
080016196	080016196L	080016196R	900	495	6	
080016197	080016197L	080016197R			7	
080016198	080016198L	080016198R			8	
0800161107	0800161107L	0800161107R	1000	545	7	
0800161108	0800161108L	0800161108R			8	
0800161109	0800161109L	0800161109R			9	



FAN IZGARALARI

- Turbo atomizatör fanları için koruyucu ızgara

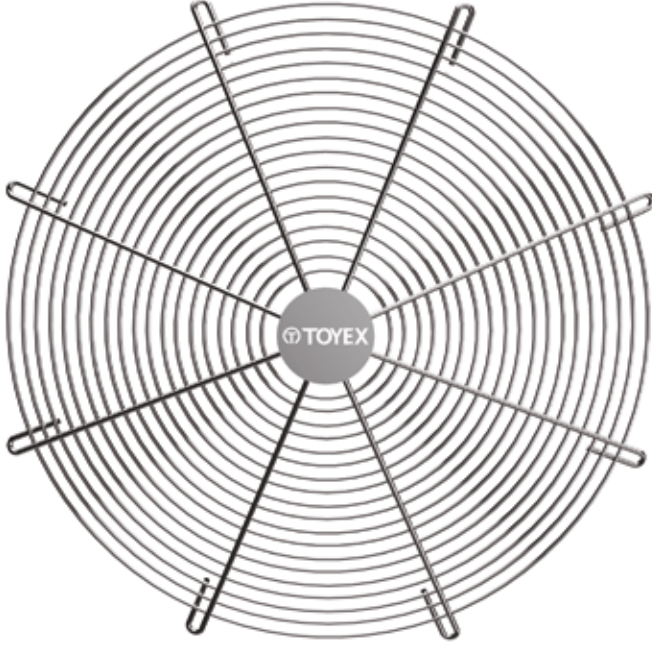

FAN PROTECTION GRID

- Fan protection grid for orchard sprayers

REJILLA DE PROTECCIÓN DE GRUPOS DE AIRE

- Rejillas de protección para grupos de aire

KOD CODE - CÓDIGO	A (mm)	Ø (mm)	Bağlantı Kanca Adedi Clamp - Abrazadera
08548580	580	500	8
08548680	680	600	
08548780	780	700	
08548880	880	800	
08548980	980	900	
085481080	1080	1000	

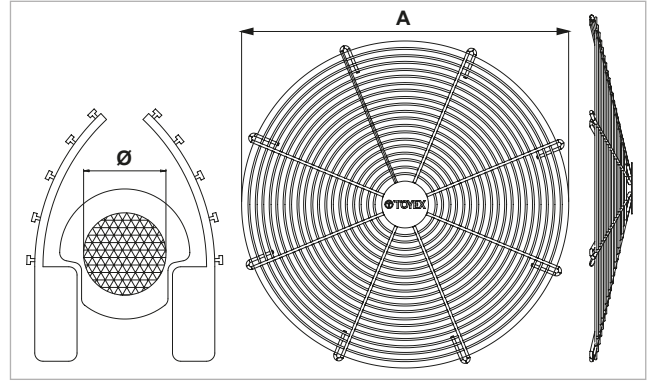

FAN DAVLUMBAZ

- Turbo atomizatör fanları için
- AISI 304 paslanmaz çelikten



STAINLESS STEEL RING

- For orchard sprayers
- AISI 304 stainless steel

CAMPANA INOXIDABLE

- Para grupos de aire
- AISI 304 acero inox

KOD CODE - CÓDIGO	Ø (mm)	Ø (")	A (mm)	B (mm)
08560006G	600	24"	640	350
08570006G	700	28"	740	350
08580006G	800	32"	840	350
08590006G	900	36"	945	350
08601000G	1000	41"	1070	350
08560006	600	24"	640	250
08570006	700	28"	740	250
08580006	800	32"	840	250
08590006	900	36"	945	250
08601000	1000	41"	1070	250

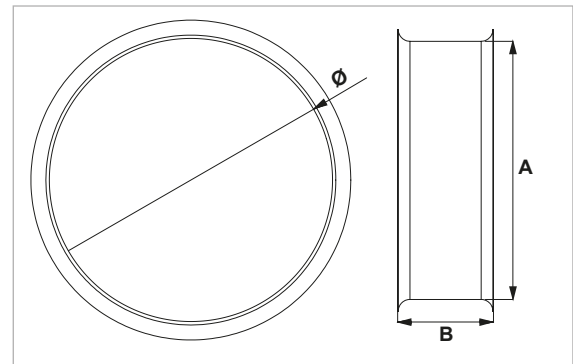



TURBO MEME KELEPÇESİ

• Montaj vidaları dahildir



NOZZLE HOLDER CLAMP

• With fixing screws

ABRAZADERA DE PORTABOQUILLAS

• Con tornillos de montaje

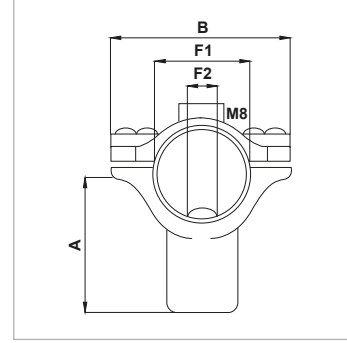

KOD - CODE - CÓDIGO	G	F1	F2	F3	A	B
08200500	G 1/4"	Ø20	Ø7	-	27,5	42
08201000		Ø21,3		-	27,5	
08201500		Ø20		-	35	
08202000		Ø21,3		-	35	
08202500		Ø21,3		M8	27,5	
08203000		Ø21,3		M8	35	

SABİT KANAT GÖBEĞİ

AIR DISTRUBITOR HUB

NÚCLEO DE DISTRIBUIDOR DE AIRE



KOD CODE - CÓDIGO	Renk - Color
08300001	Kırmızı / Red / Rojo
08300001M	Mavi / Blue / Azul
08300001S	Siyah - Black - Negro
08300001T	Turuncu - Orange - Naranja
08300001Y	Yeşil / Green / Verde



Diğer renk seçenekleri için lütfen irtibata geçiniz.
Other colors upon request. / A pedido están disponibles otros colores.



SERAMİK PLAKETLER
CERAMIC PLATES
PLACAS DE CERÁMICA



D: 15 mm	D: 18 mm	Ø (mm)
08010008	08011808	0,8
08010010	08011810	1,0
08010012	08011812	1,2
08010015	08011815	1,5
08010018	08011818	1,8
08010020	08011820	2,0
08010025	08011825	2,5

SÜZGEÇ
FILTER
FILTRO



D: 15 mm	D: 17 mm
08020000	08020001

GİRDAP DİSKİ
CONVEYOR
CONDUCTOR



D: 15 mm	D: 17 mm	Ø (mm)
08040101	08040001	-
08040110	08040010	1,0
08040112	08040012	1,2
08040115	08040015	1,5





İLAÇLAMA TABANCASI (KISA)
HANDLE SPRAY GUN
PISTOLA PULVERIZADORA



KOD - CODE - CÓDIGO	mm
08051000	360

İLAÇLAMA TABANCASI (UZUN)
HANDLE SPRAY GUN
PISTOLA PULVERIZADORA



KOD - CODE - CÓDIGO	mm
08051001	500

İLAÇLAMA TABANCASI TETİKLİ (KISA)
TRIGGER SPRAY GUN
PISTOLA PULVERIZADORA DE PALANCA



KOD - CODE - CÓDIGO	mm
08051002	330

İLAÇLAMA TABANCASI TETİKLİ (UZUN)
TRIGGER SPRAY GUN
PISTOLA PULVERIZADORA DE PALANCA



KOD - CODE - CÓDIGO	mm
08051003	600

İLAÇLAMA TABANCASI TETİKLİ (ECO)
TRIGGER SPRAY GUN
PISTOLA PULVERIZADORA DE PALANCA



KOD - CODE - CÓDIGO	mm
08051004	240

İLAÇLAMA TABANCASI TETİKLİ (YABANCI OT İLAÇLAMA)
TRIGGER SPRAY GUN
PISTOLA PULVERIZADORA DE PALANCA



KOD - CODE - CÓDIGO	mm
08051005	1000



İLAÇLAMA TABANÇASI TETİKLİ
TRIGGER SPRAY GUN
PISTOLA PULVERIZADORA DE PALANCA



KOD - CODE - CÓDIGO	mm
08051006	250

TABANCA UCU
NOZZLE WITH CERAMIC INSERT
BOQUILLA CON INSERTO DE CERÁMICA



KOD - CODE - CÓDIGO	Ø (mm)
08060010	1,0
08060015	1,5
08060018	1,8
08060020	2,0
08060025	2,5
08060030	3,0

DÖNER NİPEL
SWIVEL FITTING
RACOR GIRATORIO



KOD - CODE - CÓDIGO	F
08051050	G ½"

L - DÖNER NİPEL
L - SWIVEL FITTING
RACOR GIRATORIO



KOD - CODE - CÓDIGO	F
09033913	G ½"

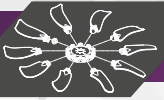

BORA 230 AYARLI PERVANE DÜZ

- Yüksek Dayanımlı Plastik Gövde ve Kanatlar
- 5 Farklı Ayar Seçeneği
- Pervane Dönüş Yönü: Sol - Sağ
- Maksimum Traktör Gücü 55 Beygir

Pervane Çapı	28", 32", 36"
Kanat Tipi	Seri 1 Düz Kanat
Göbek Tipi	Küçük Göbek
Göbek Çapı	230 mm

BORA 230 ADJUSTABLE FAN

- Glass Reinforced Polyamide Hub And Blades
- Adjustable Blades
- Rotation Direction: Counterclockwise - Clockwise
- Maximum Tractor Power 55 HP

Diameter	28", 32", 36"
Blade Type	Type 1
Hub Type	Small Hub
Hub Diameter	230 mm

BORA 230 VENTILADOR REGULABLE

- Aletas y Núcleo de polimida reforzada con fibra de vidrio
- Aletas regulables
- La dirección de giro: Izquierda - Derecha
- La potencia máxima del tractor 55 HP

Diámetro	28", 32", 36"
Tipo de Aletas	Tipo 1
Tipo de Núcleo	Núcleo Pequeño
Diámetro de Núcleo	230 mm



KOD CODE - CÓDIGO	D	Yön Direction Dirección	Renk Color
KP1P08CW28B	28"	Sol Left Izquierda	Siyah Black Negro
KP1P08CW32B	32"		
KP1P08CW36B	36"		
KP1P08C28B	28"	Sağ Right Derecha	
KP1P08C32B	32"		
KP1P08C36B	36"		

YEDEK PARÇA / SPARE PARTS / REPUESTOS

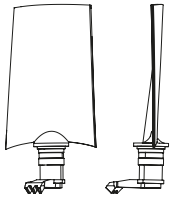

KOD CODE - CÓDIGO	L	Yön Direction Dirección	Renk Color
08101002CW	240 mm	Sol Left Izquierda	Siyah Black Negro
08101011CW	290 mm		
08101021CW	325 mm		
08101002C	240 mm	Sağ Right Derecha	
08101011C	290 mm		
08101021C	325 mm		

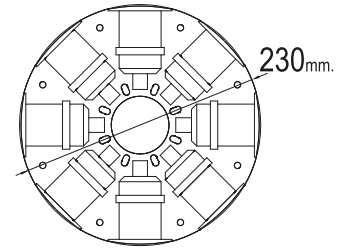

Ayar Anahtarı
Adjustment Lock Tool
Herramienta de ajuste

08110001



Pervane Flanşı (Küçük)
Flange
Brida

08110002



Göbek Komple (Küçük)
Hub With All Parts
Núcleo Completo

Yön
Direction
Dirección

Renk
Color

08101006	Sol - Left Izquierda	Kırmızı - Red - Rojo
08101006S		Sarı - Yellow - Amarillo
08101006C	Sağ - Right Derecha	Kırmızı - Red - Rojo
08101006CS		Sarı - Yellow - Amarillo

Ayar anahtarı ayrıca sipariş edilmelidir
Adjustment tool must be ordered separately
Llave de ajuste debe pedirse por separado

Flanş göbekleri işlenmemiştir
Not machined according to gearbox
El núcleo de brida no mecanizado



BORA 300 AYARLI PERVANE DÜZ

- Yüksek Dayanımlı Plastik Gövde ve Kanatlar
- 5 Farklı Ayar Seçeneği
- Pervane Dönüş Yönü: Sol - Sağ
- Maksimum Traktör Gücü 55 Beygir

Pervane Çapı	36"
Kanat Tipi	Seri 1 Düz Kanat
Göbek Tipi	Büyük Göbek
Göbek Çapı	300 mm

BORA 300 ADJUSTABLE FAN

- Glass Reinforced Polyamide Hub And Blades
- Adjustable Blades
- Rotation Direction: Counterclockwise - Clockwise
- Maximum Tractor Power 55 HP

Diameter	36"
Blade Type	Type 1
Hub Type	Big Hub
Hub Diameter	300 mm

BORA 300 VENTILADOR REGULABLE

- Aletas y Núcleo de polimiada reforzada con fibra de vidrio
- Aletas regulables
- La dirección de giro: Izquierda - Derecha
- La potencia máxima del tractor 55 HP

Diámetro	36"
Tipo de Aletas	Tipo 1
Tipo de Núcleo	Núcleo Grande
Diámetro de Núcleo	300 mm



KOD CODE - CÓDIGO	D	Yön Direction Dirección	Renk Color
BP1P08CW36B	36"	Sol - Left Izquierda	Siyah - Black - Negro
BP1P08CW36S			Sarı - Yellow - Amarillo
BP1P08C36B		Sağ - Right Derecha	Siyah - Black - Negro
BP1P08C36S			Sarı - Yellow - Amarillo

YEDEK PARÇA / SPARE PARTS / REPUESTOS

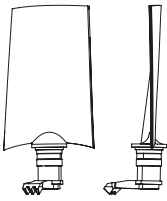

KOD CODE - CÓDIGO	L	Yön Direction Dirección	Renk Color
08101011CWS	290 mm	Sol - Left Izquierda	Sarı - Yellow - Amarillo
08101011CW			Siyah - Black - Negro
08101011CS		Sağ - Right Derecha	Sarı - Yellow - Amarillo
08101011C			Siyah - Black - Negro

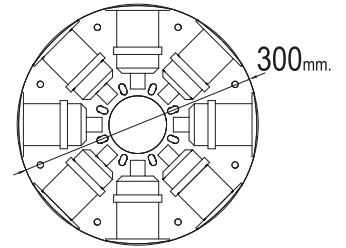

Ayar Anahtarı
Adjustment Lock Tool
Herramienta de ajuste

08110001



Pervane Flanşı (Büyük)
Flange
Brida

08110003



Göbek Komple (Büyük) Hub With All Parts Núcleo Completo	Yön Direction Dirección	Renk Color
08101007	Sol - Left Izquierda	Kırmızı - Red - Rojo
08101007S		Sarı - Yellow - Amarillo
08101007C	Sağ - Right Derecha	Kırmızı - Red - Rojo
08101007CS		Sarı - Yellow - Amarillo

Ayar anahtarı ayrıca sipariş edilmelidir
Adjustment tool must be ordered separately
Llave de ajuste debe pedirse por separado

Flanş göbekleri işlenmemiştir
Not machined according to gearbox
El núcleo de brida no mecanizado



TAYFUN 230 AYARLI PERVANE EĞİMLİ

- Yüksek Dayanımlı Plastik Gövde ve Kanatlar
- 5 Farklı Ayar Seçeneği
- Pervane Dönüş Yönü: Sol - Sağ
- Maksimum Traktör Gücü 55 Beygir

Pervane Çapı	32"
Kanat Tipi	Seri 2 Eğimli Kanat
Göbek Tipi	Küçük Göbek
Göbek Çapı	230 mm

TAYFUN 230 ADJUSTABLE FAN

- Glass Reinforced Polyamide Hub And Blades
- Adjustable Blades
- Rotation Direction: Counterclockwise - Clockwise
- Maximum Tractor Power 55 HP

Diameter	32"
Blade Type	Type 2
Hub Type	Small Hub
Hub Diameter	230 mm

TAYFUN 230 VENTILADOR REGULABLE

- Aletas y Núcleo de polimida reforzada con fibra de vidrio
- Aletas regulables
- La dirección de giro: Izquierda - Derecha
- La potencia máxima del tractor 55 HP

Diámetro	32"
Tipo de Aletas	Tipo 2
Tipo de Núcleo	Núcleo Pequeño
Diámetro de Núcleo	230 mm



KOD CODE - CÓDIGO	D	Yön Direction Dirección	Renk Color
KP2P08CW32B	32"	Sol - Left Izquierda	Siyah - Black - Negro
KP2P08CW32S			Sarı - Yellow - Amarillo
KP2P08CW32T			Turuncu - Orange - Naranja
KP2P08C32B		Sağ - Right Derecha	Siyah - Black - Negro
KP2P08C32S			Sarı - Yellow - Amarillo
KP2P08C32T			Turuncu - Orange - Naranja

YEDEK PARÇA / SPARE PARTS / REPUESTOS

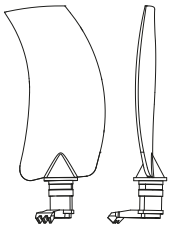

KOD CODE - CÓDIGO	L	Yön Direction Dirección	Renk Color
08101011CW1	290 mm	Sol - Left Izquierda	Siyah - Black - Negro
08101011CW1S			Sarı - Yellow - Amarillo
08101011CW1T			Turuncu - Orange - Naranja
08101011C1		Sağ - Right Derecha	Siyah - Black - Negro
08101011C1S			Sarı - Yellow - Amarillo
08101011C1T			Turuncu - Orange - Naranja

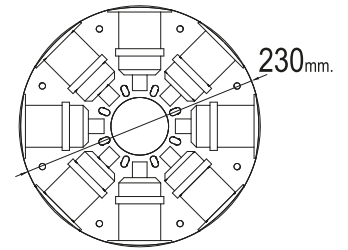

Ayar Anahtarı
Adjustment Lock Tool
Herramienta de ajuste

08110001



Pervane Flanşı (Küçük)
Flange
Brida

08110002



Göbek Komple (Küçük)
Hub With All Parts
Núcleo Completo

Yön
Direction
Dirección

Renk
Color

08101006	Sol - Left Izquierda	Kırmızı - Red - Rojo
08101006S		Sarı - Yellow - Amarillo
08101006T		Turuncu - Orange - Naranja
08101006C	Sağ - Right Derecha	Kırmızı - Red - Rojo
08101006CS		Sarı - Yellow - Amarillo
08101006CT		Turuncu - Orange - Naranja

Ayar anahtarı ayrıca sipariş edilmelidir
Adjustment tool must be ordered separately
Llave de ajuste debe pedirse por separado

Flanş göbekleri işlenmemiştir
Not machined according to gearbox
El núcleo de brida no mecanizado

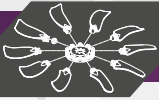

TAYFUN 300 AYARLI PERVANE EĞİMLİ

- Yüksek Dayanımlı Plastik Gövde ve Kanatlar
- 5 Farklı Ayar Seçeneği
- Pervane Dönüş Yönü: Sol - Sağ
- Maksimum Traktör Gücü 55 Beygir

Pervane Çapı	36"
Kanat Tipi	Seri 2 Eğimli Kanat
Göbek Tipi	Büyük Göbek
Göbek Çapı	300 mm

TAYFUN 300 ADJUSTABLE FAN

- Glass Reinforced Polyamide Hub And Blades
- Adjustable Blades
- Rotation Direction: Counterclockwise - Clockwise
- Maximum Tractor Power 55 HP

Diameter	36"
Blade Type	Type 2
Hub Type	Big Hub
Hub Diameter	300 mm

TAYFUN 300 VENTILADOR REGULABLE

- Aletas y Núcleo de polimida reforzada con fibra de vidrio
- Aletas regulables
- La dirección de giro: Izquierda - Derecha
- La potencia máxima del tractor 55 HP

Diámetro	36"
Tipo de Aletas	Tipo 2
Tipo de Núcleo	Núcleo Grande
Diámetro de Núcleo	300 mm



KOD CODE - CÓDIGO	D	Yön Direction Dirección	Renk Color
BP2P08CW36B	36"	Sol - Left Izquierda	Siyah - Black - Negro
BP2P08CW36S			Sarı - Yellow - Amarillo
BP2P08CW36T			Turuncu - Orange - Naranja
BP2P08C36B		Sağ - Right Derecha	Siyah - Black - Negro
BP2P08C36S			Sarı - Yellow - Amarillo
BP2P08C36T			Turuncu - Orange - Naranja

YEDEK PARÇA / SPARE PARTS / REPUESTOS

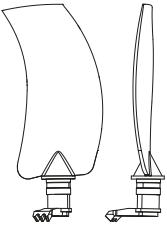

KOD CODE - CÓDIGO	L	Yön Direction Dirección	Renk Color
08101011CW1	290 mm	Sol - Left Izquierda	Siyah - Black - Negro
08101011CW1S			Sarı - Yellow - Amarillo
08101011CW1T			Turuncu - Orange - Naranja
08101011C1		Sağ - Right Derecha	Siyah - Black - Negro
08101011C1S			Sarı - Yellow - Amarillo
08101011C1T			Turuncu - Orange - Naranja

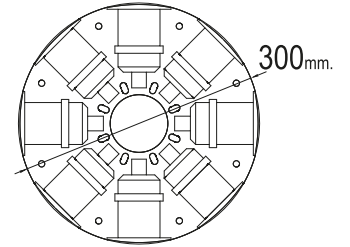

Ayar Anahtarı
Adjustment Lock Tool
Herramienta de ajuste

08110001



Pervane Flanşı (Büyük)
Flange
Brida

08110003



Göbek Komple (Büyük) Hub With All Parts Núcleo Completo	Yön Direction Dirección	Renk Color
08101007	Sol - Left Izquierda	Kırmızı - Red - Rojo
08101007S		Sarı - Yellow - Amarillo
08101007T		Turuncu - Orange - Naranja
08101007C	Sağ - Right Derecha	Kırmızı - Red - Rojo
08101007CS		Sarı - Yellow - Amarillo
08101007CT		Turuncu - Orange - Naranja

Ayar anahtarı ayrıca sipariş edilmelidir
Adjustment tool must be ordered separately
Llave de ajuste debe pedirse por separado

Flanş göbekleri işlenmemiştir
Not machined according to gearbox
El núcleo de brida no mecanizado



VENTO 250 ALÜMİNYUM PERVANE

- Alüminyum Gövde ve Yüksek Dayanımlı Plastik Kanatlar
- 30° / 45° / 60° Açı Seçenekleri
- Pervane Dönüş Yönü: Sol
- Traktör Güç Aralığı 55 - 95 Beygir

Pervane Çapı	32"
Kanat Tipi	Tip 4 Kanat
Göbek Çapı	250 mm

VENTO 250 ALUMINIUM HUB FAN

- Aluminium Hub and Glass Reinforced Polyamide Blades
- 30° / 45° / 60° Pitch Angle Options
- Rotation Direction: Counterclockwise
- Tractor Power Range 55 - 95 HP

Diameter	32"
Blade Type	Type 4
Hub Diameter	250 mm

VENTO 250 VENTILADOR CON NÚCLEO DE ALUMINIO

- Núcleo de aluminio y aletas de polimiada reforzada con fibra de vidrio
- Opciones de ángulos 30° / 45° / 60°
- La dirección de giro: Izquierda
- La potencia máxima del tractor 55 - 95 HP

Diámetro	32"
Tipo de Aletas	Tip 4
Diámetro de Núcleo	250 mm



KOD CODE - CÓDIGO	Balatalı - With Clutch Con Embrague	D	Açı Angle Ángulo	Yön Direction Dirección	Renk Color
KA4AP10CW3032T	KA4AP10CW3032TC	32"	30°	Sol	Turuncu
KA4AP10CW4532T	KA4AP10CW4532TC		45°	Left	Orange
KA4AP10CW6032T	KA4AP10CW6032TC		60°	Izquierda	Naranja

YEDEK PARÇA / SPARE PARTS / REPUESTOS



KOD CODE - CÓDIGO	L	Yön Direction Dirección	Renk Color
08101213CW32	280 mm	Sol - Left Izquierda	Turuncu Orange - Naranja

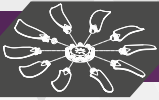

ANEMOS 250 ALÜMİNYUM PERVANE DÜZ

- Alüminyum Gövde ve Yüksek Dayanımlı Plastik Kanatlar
- 30° / 45° / 60° Açı Seçenekleri
- Pervane Dönüş Yönü: Sol - Sağ
- Traktör Güç Aralığı 55 - 95 Beygir

Pervane Çapı	28", 32", 36"
Kanat Tipi	Tip 1 Düz Kanat
Göbek Çapı	250 mm

ANEMOS 250 ALUMINIUM HUB FAN

- Aluminium Hub and Glass Reinforced Polyamide Blades
- 30° / 45° / 60° Pitch Angle Options
- Rotation Direction: Counterclockwise - Clockwise
- Tractor Power Range 55 - 95 HP

Diameter	28", 32", 36"
Blade Type	Type 1
Hub Diameter	250 mm

ANEMOS 250 VENTILADOR CON NÚCLEO DE ALUMINIO

- Núcleo de aluminio y aletas de polimida reforzada con fibra de vidrio
- Opciones de ángulos 30° / 45° / 60°
- La dirección de giro: Izquierda - Derecha
- La potencia máxima del tractor 55 - 95 HP

Diámetro	28", 32", 36"
Tipo de Aletas	Tipo 1
Diámetro de Núcleo	250 mm



KOD CODE - CÓDIGO	Balatalı - With Clutch Con Embrague	D	Açı Angle Ángulo	Yön Direction Dirección	Renk Color
KA1AP10CW3028K	KA1AP10CW3028KC	28"	30°	Sol Left Izquierda	Kırmızı Red Rojo
KA1AP10CW4528K	KA1AP10CW4528KC		45°		
KA1AP10CW6028K	KA1AP10CW6028KC		60°		
KA1AP10CW3032K	KA1AP10CW3032KC	32"	30°		
KA1AP10CW4532K	KA1AP10CW4532KC		45°		
KA1AP10CW6032K	KA1AP10CW6032KC		60°		
KA1AP10CW3036K	KA1AP10CW3036KC	36"	30°		
KA1AP10CW4536K	KA1AP10CW4536KC		45°		
KA1AP10CW6036K	KA1AP10CW6036KC		60°		
KA1AP10C3028K	KA1AP10C3028KC	28"	30°	Sağ Right Derecha	
KA1AP10C4528K	KA1AP10C4528KC		45°		
KA1AP10C6028K	KA1AP10C6028KC		60°		
KA1AP10C3032K	KA1AP10C3032KC	32"	30°		
KA1AP10C4532K	KA1AP10C4532KC		45°		
KA1AP10C6032K	KA1AP10C6032KC		60°		
KA1AP10C3036K	KA1AP10C3036KC	36"	30°		
KA1AP10C4536K	KA1AP10C4536KC		45°		
KA1AP10C6036K	KA1AP10C6036KC		60°		

YEDEK PARÇA / SPARE PARTS / REPUESTOS

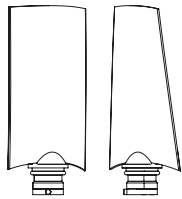

KOD CODE - CÓDIGO	L	Yön Direction Dirección	Renk Color
08101210CW28	240 mm	Sol Left Izquierda	Kırmızı Red Rojo
08101210CW32	290 mm		
08101210CW36	325 mm		
08101210C28	240 mm	Sağ Right Derecha	
08101210C32	290 mm		
08101210C36	325 mm		

Pervanelerimiz min. Ø 700 mm - Max. Ø 950 mm çaplarına kadar mevcuttur. Diğer renk ve ölçü seçenekleri için lütfen firmamız ile irtibata geçiniz.
Available dimensions between Ø 700 mm - Ø 950 mm. Please contact with us for other colour and size options.
Disponibles las dimensiones entre min. Ø 700 mm - max. Ø 950 mm. Póngase en contacto con nuestra empresa para otras opciones de color y tamaño.

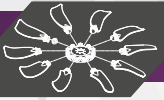

ANEMOS 250 ALÜMİNYUM PERVANE DÜZ / 8 KANAT

- Alüminyum Gövde ve Yüksek Dayanımlı Plastik Kanatlar
- 30° / 45° / 60° Açı Seçenekleri
- Pervane Dönüş Yönü: Sol - Sağ
- Traktör Güç Aralığı 55 - 95 Beygir

Pervane Çapı	28", 32", 36"
Kanat Tipi	Tip 1 Düz Kanat
Göbek Çapı	250 mm

ANEMOS 250 ALUMINIUM HUB FAN

- Aluminium Hub and Glass Reinforced Polyamide Blades
- 30° / 45° / 60° Pitch Angle Options
- Rotation Direction: Counterclockwise - Clockwise
- Tractor Power Range 55 - 95 HP

Diameter	28", 32", 36"
Blade Type	Type 1
Hub Diameter	250 mm

ANEMOS 250 VENTILADOR CON NÚCLEO DE ALUMINIO

- Núcleo de aluminio y aletas de polimida reforzada con fibra de vidrio
- Opciones de ángulos 30° / 45° / 60°
- La dirección de giro: Izquierda - Derecha
- La potencia máxima del tractor 55 - 95 HP

Diámetro	28", 32", 36"
Tipo de Aletas	Tipo 1
Diámetro de Núcleo	250 mm



KOD CODE - CÓDIGO	D	Açı Angle Ángulo	Yön Direction Dirección	Renk Color
KA1AP08CW3028K	28"	30°	Sol Left Izquierda	Kırmızı Red Rojo
KA1AP08CW4528K		45°		
KA1AP08CW6028K		60°		
KA1AP08CW3032K	32"	30°		
KA1AP08CW4532K		45°		
KA1AP08CW6032K		60°		
KA1AP08CW3036K	36"	30°		
KA1AP08CW4536K		45°		
KA1AP08CW6036K		60°		
KA1AP08C3028K	28"	30°	Sağ Right Derecha	
KA1AP08C4528K		45°		
KA1AP08C6028K		60°		
KA1AP08C3032K	32"	30°		
KA1AP08C4532K		45°		
KA1AP08C6032K		60°		
KA1AP08C3036K	36"	30°		
KA1AP08C4536K		45°		
KA1AP08C6036K		60°		

YEDEK PARÇA / SPARE PARTS / REPUESTOS

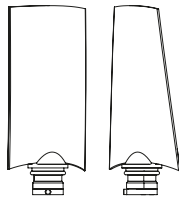

KOD CODE - CÓDIGO	L	Yön Direction Dirección	Renk Color
08101210CW28	240 mm	Sol Left Izquierda	Kırmızı Red Rojo
08101210CW32	290 mm		
08101210CW36	325 mm		
08101210C28	240 mm	Sağ Right Derecha	
08101210C32	290 mm		
08101210C36	325 mm		

Pervanelerimiz min. Ø 700 mm - Max. Ø 950 mm çaplarına kadar mevcuttur. Diğer renk ve ölçü seçenekleri için lütfen firmamız ile irtibata geçiniz.
Available dimensions between Ø 700 mm - Ø 950 mm. Please contact with us for other colour and size options.
Disponibles las dimensiones entre min. Ø 700 mm - max. Ø 950 mm. Póngase en contacto con nuestra empresa para otras opciones de color y tamaño.



ANEMOS 330 ALÜMİNYUM PERVA NE DÜZ

- Alüminyum Gövde ve Yüksek Dayanımlı Plastik Kanatlar
- 30° / 45° / 60° Açı Seçenekleri
- Pervane Dönüş Yönü: Sol
- Traktör Güç Aralığı 55 - 95 Beygir

Pervane Çapı	41"
Kanat Tipi	Tip 1 Düz Kanat
Göbek Çapı	330 mm

ANEMOS 330 ALUMINIUM HUB FAN

- Aluminium Hub and Glass Reinforced Polyamide Blades
- 30° / 45° / 60° Pitch Angle Options
- Rotation Direction: Counterclockwise
- Tractor Power Range 55 - 95 HP

Diameter	41"
Blade Type	Type 1
Hub Diameter	330 mm

ANEMOS 330 VENTILADOR CON NÚCLEO DE ALUMINIO

- Núcleo de aluminio y aletas de polimida reforzada con fibra de vidrio
- Opciones de ángulos 30° / 45° / 60°
- La dirección de giro: Izquierda
- La potencia máxima del tractor 55 - 95 HP

Diámetro	41"
Tipo de Aletas	Tipo 1
Diámetro de Núcleo	330 mm



KOD CODE - CÓDIGO	Balatalı - With Clutch Con Embrague	D	Açı Angle Ángulo	Yön Direction Dirección	Renk Color
BA1AP10CW3041T	BA1AP10CW3041TC	41"	30°	Sol Left Izquierda	Turuncu Orange Naranja
BA1AP10CW4541T	BA1AP10CW4541TC		45°		
BA1AP10CW6041T	BA1AP10CW6041TC		60°		
BA1AP10CW3041B	BA1AP10CW3041BC		30°		Siyah Black Negro
BA1AP10CW4541B	BA1AP10CW4541BC		45°		
BA1AP10CW6041B	BA1AP10CW6041BC		60°		

YEDEK PARÇA / SPARE PARTS / REPUESTOS

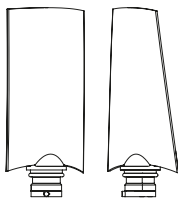

KOD CODE - CÓDIGO	L	Yön Direction Dirección	Renk Color
08101218CW41T	325 mm	Sol - Left	Turuncu - Orange - Naranja
08101218CW41S		Izquierda	Siyah - Black - Negro



Balatalı Flanş
Flange With Clutch
Brida Con Embrague

08101300

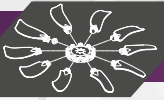

TORNADO 250 ALÜMİNYUM PERVANE / 8 KANAT

- Alüminyum Gövde ve Yüksek Dayanımlı Plastik Kanatlar
- 30° / 45° / 60° Açı Seçenekleri
- Pervane Dönüş Yönü: Sol - Sağ
- Traktör Güç Aralığı 55 - 95 Beygir

Pervane Çapı	32"
Kanat Tipi	Tip 2 Eğimli Kanat
Göbek Çapı	250 mm

TORNADO 250 ALUMINIUM HUB FAN

- Aluminium Hub and Glass Reinforced Polyamide Blades
- 30° / 45° / 60° Pitch Angle Options
- Rotation Direction: Counterclockwise - Clockwise
- Tractor Power Range 55 - 95 HP



















Diameter	32"
Blade Type	Type 2
Hub Diameter	250 mm

TORNADO 250 VENTILADOR CON NÚCLEO DE ALUMINIO

- Núcleo de aluminio y aletas de polimida reforzada con fibra de vidrio
- Opciones de ángulos 30° / 45° / 60°
- La dirección de giro: Izquierda - Derecha
- La potencia máxima del tractor 55 - 95 HP

Diámetro	32"
Tipo de Aletas	Tipo 2
Diámetro de Núcleo	250 mm



KOD CODE - CÓDIGO	D	Açı Angle Ángulo	Yön Direction Dirección	Renk Color	
KA2AP08CW3032T	32"	 30°	Sol Left Izquierda	Turuncu Orange Naranja	
KA2AP08CW4532T		 45°			
KA2AP08CW6032T		 60°			
KA2AP08CW3032S		 30°		Sağ Right Derecha	Sarı Yellow Amarillo
KA2AP08CW4532S		 45°			
KA2AP08CW6032S		 60°			
KA2AP08CW3032K		 30°		Kırmızı Red Rojo	
KA2AP08CW4532K		 45°			
KA2AP08CW6032K		 60°			
KA2AP08C3032T		32"	 30°	Sağ Right Derecha	Turuncu Orange Naranja
KA2AP08C4532T			 45°		
KA2AP08C6032T			 60°		
KA2AP08C3032S			 30°		Sarı Yellow Amarillo
KA2AP08C4532S			 45°		
KA2AP08C6032S			 60°		
KA2AP08C3032K			 30°		Kırmızı Red Rojo
KA2AP08C4532K			 45°		
KA2AP08C6032K			 60°		

YEDEK PARÇA / SPARE PARTS / REPUESTOS

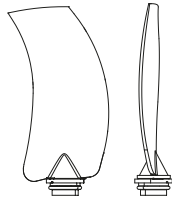

KOD CODE - CÓDIGO	L	Yön Direction Dirección	Renk Color
08101211CW32T	280 mm	Sol Left Izquierda	Turuncu - Orange - Naranja
08101211CW32S			Sarı - Yellow - Amarillo
08101211CW32K			Kırmızı - Red - Rojo
08101211C32T		Sağ Right Derecha	Turuncu - Orange - Naranja
08101211C32S			Sarı - Yellow - Amarillo
08101211C32K			Kırmızı - Red - Rojo

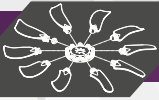

TORNADO 330 ALÜMİNYUM PERVANE

- Alüminyum Gövde ve Yüksek Dayanımlı Plastik Kanatlar
- 30° / 45° / 60° Açı Seçenekleri
- Pervane Dönüş Yönü: Sol - Sağ
- Traktör Güç Aralığı 55 - 95 Beygir

Pervane Çapı	36"
Kanat Tipi	Tip 2 Eğimli Kanat
Göbek Çapı	330 mm

TORNADO 330 ALUMINIUM HUB FAN

- Aluminium Hub and Glass Reinforced Polyamide Blades
- 30° / 45° / 60° Pitch Angle Options
- Rotation Direction: Counterclockwise - Clockwise
- Tractor Power Range 55 - 95 HP

Diameter	36"
Blade Type	Type 2
Hub Diameter	330 mm

TORNADO 330 VENTILADOR CON NÚCLEO DE ALUMINIO

- Núcleo de aluminio y aletas de polimada reforzada con fibra de vidrio
- Opciones de ángulos 30° / 45° / 60°
- La dirección de giro: Izquierda - Derecha
- La potencia máxima del tractor 55 - 95 HP

Diámetro	36"
Tipo de Aletas	Tipo 2
Diámetro de Núcleo	330 mm



KOD CODE - CÓDIGO	Balatalı - With Clutch Con Embrague	D	Açı Angle Ángulo	Yön Direction Dirección	Renk Color	
BA2AP10CW3036T	BA2AP10CW3036TC	36"	30°	Sol Left Izquierda	Turuncu Orange Naranja	
BA2AP10CW4536T	BA2AP10CW4536TC		45°			
BA2AP10CW6036T	BA2AP10CW6036TC		60°			
BA2AP10CW3036S	BA2AP10CW3036SC		30°		Sağ Right Derecha	Sarı Yellow Amarillo
BA2AP10CW4536S	BA2AP10CW4536SC		45°			
BA2AP10CW6036S	BA2AP10CW6036SC		60°			
BA2AP10CW3036R	BA2AP10CW3036RC		30°		Kırmızı Red Rojo	
BA2AP10CW4536R	BA2AP10CW4536RC		45°			
BA2AP10CW6036R	BA2AP10CW6036RC		60°			
BA2AP10C3036T	BA2AP10C3036TC		36"	30°	Sağ Right Derecha	Turuncu Orange Naranja
BA2AP10C4536T	BA2AP10C4536TC			45°		
BA2AP10C6036T	BA2AP10C6036TC			60°		
BA2AP10C3036S	BA2AP10C3036SC			30°		Sarı Yellow Amarillo
BA2AP10C4536S	BA2AP10C4536SC			45°		
BA2AP10C6036S	BA2AP10C6036SC			60°		
BA2AP10C3036R	BA2AP10C3036RC			30°		Kırmızı Red Rojo
BA2AP10C4536R	BA2AP10C4536RC			45°		
BA2AP10C6036R	BA2AP10C6036RC			60°		

YEDEK PARÇA / SPARE PARTS / REPUESTOS

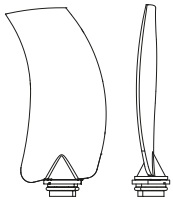

KOD CODE - CÓDIGO	L	Yön Direction Dirección	Renk Color
08101215CW32T	280 mm	Sol Left Izquierda	Turuncu - Orange - Turuncu
08101215CW32S			Sarı - Yellow - Amarillo
08101215CW32K			Kırmızı - Red - Rojo
08101215C32T		Sağ Right Derecha	Turuncu - Orange - Turuncu
08101215C32S			Sarı - Yellow - Amarillo
08101215C32K			Kırmızı - Red - Rojo



Balatalı Flanş
Flange With Clutch
Brida Con Embrague

08101300

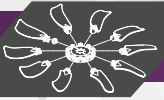

DRAGON 330 ALÜMİNYUM PERVANE HELİS

- Alüminyum Gövde ve Yüksek Dayanımlı Plastik Kanatlar
- 45° / 60° / 75° Açı Seçenekleri
- Pervane Dönüş Yönü: Sol
- Traktör Güç Aralığı 55 - 95 Beygir

Pervane Çapı	36"
Kanat Tipi	Tip 3 Helis Kanat
Göbek Çapı	330 mm

DRAGON 330 ALUMINIUM HUB FAN

- Aluminium Hub and Glass Reinforced Polyamide Blades
- 45° / 60° / 75° Pitch Angle Options
- Rotation Direction: Counterclockwise
- Tractor Power Range 55 - 95 HP

Diameter	36"
Blade Type	Type 3
Hub Diameter	330 mm

DRAGON 330 VENTILADOR CON NÚCLEO DE ALUMINIO

- Núcleo de aluminio y aletas de polimida reforzada con fibra de vidrio
- Opciones de ángulos 45° / 60° / 75°
- La dirección de giro: Izquierda
- La potencia máxima del tractor 55 - 95 HP

Diámetro	36"
Tipo de Aletas	Tipo 3
Diámetro de Núcleo	330 mm



KOD CODE - CÓDIGO	Balatalı - With Clutch Con Embrague	D	Açı Angle Ángulo	Yön Direction Dirección	Renk Color
BA3AP10CW4536K	BA3AP10CW4536KC	36"	45°	Sol	Kırmızı
BA3AP10CW6036K	BA3AP10CW6036KC		60°	Left	Red
BA3AP10CW7536K	BA3AP10CW7536KC		75°	Izquierda	Rojo

YEDEK PARÇA / SPARE PARTS / REPUESTOS

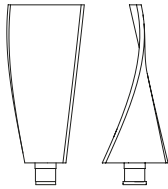

KOD CODE - CÓDIGO	L	Yön Direction Dirección	Renk Color
08101212CW32	285 mm	Sol - Left Izquierda	Kırmızı Red - Rojo



Balatalı Flanş
Flange With Clutch
Brida Con Embrague

08101300

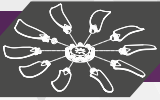

POYRAZ ALÜMİNYUM PERVANE / 12 KANAT

- Alüminyum Gövde ve Yüksek Dayanımlı Plastik Kanatlar
- 30° / 45° / 60° Açı Seçenekleri
- Pervane Dönüş Yönü: Sol
- Traktör Güç Aralığı 55 - 95 Beygir

Pervane Çapı	32", 36"
Kanat Tipi	Tip 5
Göbek Çapı	280 mm

POYRAZ ALUMINIUM HUB FAN

- Aluminium Hub and Glass Reinforced Polyamide Blades
- 30° / 45° / 60° Pitch Angle Options
- Rotation Direction: Counterclockwise
- Tractor Power Range 55 - 95 HP

Diameter	32", 36"
Blade Type	Type 5
Hub Diameter	280 mm

POYRAZ VENTILADOR CON NÚCLEO DE ALUMINIO

- Núcleo de aluminio y aletas de polimada reforzada con fibra de vidrio
- Opciones de ángulos 30° / 45° / 60°
- La dirección de giro: Izquierda
- La potencia máxima del tractor 55 - 95 HP

Diámetro	32", 36"
Tipo de Aletas	Tipo 5
Diámetro de Núcleo	280 mm



KOD CODE - CÓDIGO	D	Açı Angle Ángulo	Yön Direction Dirección	Renk Color
BA5AP12CW3032M	32"	30°	Sol Left Izquierda	Mavi Blue Azul
BA5AP12CW4532M		45°		
BA5AP12CW6032M		60°		
BA5AP12CW3036M	36"	30°		
BA5AP12CW4536M		45°		
BA5AP12CW6036M		60°		
BA5AP12CW3032Y	32"	30°	Sol Left Izquierda	Yeşil Green Verde
BA5AP12CW4532Y		45°		
BA5AP12CW6032Y		60°		
BA5AP12CW3036Y	36"	30°		
BA5AP12CW4536Y		45°		
BA5AP12CW6036Y		60°		

YEDEK PARÇA / SPARE PARTS / REPUESTOS

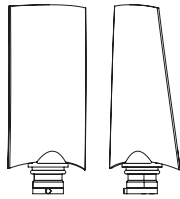

KOD CODE - CÓDIGO	L	Yön Direction Dirección	Renk Color
08101216CW32M	290 mm	Sol - Left Izquierda	Mavi Blue - Azul
08101216CW36M	325 mm		



Flaş
Flange
Brida

08110021

Pervanelerimiz min. Ø 700 mm - Max. Ø 915 mm çaplarına kadar mevcuttur. Diğer renk ve ölçü seçenekleri için lütfen firmamız ile irtibata geçiniz.
Available dimensions between Ø 700 mm - Ø 915 mm. Please contact with us for other colour and size options.
Disponibles las dimensiones entre min. Ø 700 mm - max. Ø 915 mm. Póngase en contacto con nuestra empresa para otras opciones de color y tamaño.



FLANŞ (K230)

- Tip: İşlenmemiş
- Flanş Malzemesi: Döküm
- Göbek Tipi: Plastik
- Pervane Tipi: Bora 230 / Tayfun 230



FLANGE

- Type: Not Machined
- Flange Material: Cast Iron
- Hub Type: Plastic
- Fan Type: Bora 230 / Tayfun 230

KOD - CODE - CÓDIGO

08110002

BRIDA

- Tipo: No mecanizado
- Material: Hierro fundido
- Tipo de Núcleo: Plástico
- Tipo de Ventilador: Bora 230 / Tayfun 230

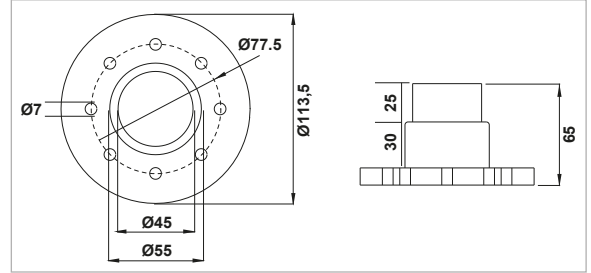

FLANŞ (B300)

- Tip: İşlenmemiş
- Flanş Malzemesi: Döküm
- Göbek Tipi: Plastik
- Pervane Tipi: Bora 300 / Tayfun 300
Dragon 330



FLANGE

- Type: Not Machined
- Flange Material: Cast Iron
- Hub Type: Plastic
- Fan Type: Bora 300 / Tayfun 300
Dragon 330

KOD - CODE - CÓDIGO

08110003

BRIDA

- Tipo: No mecanizado
- Material: Hierro fundido
- Tipo de Núcleo: Plástico
- Tipo de Ventilador: Bora 300 / Tayfun 300
Dragon 330

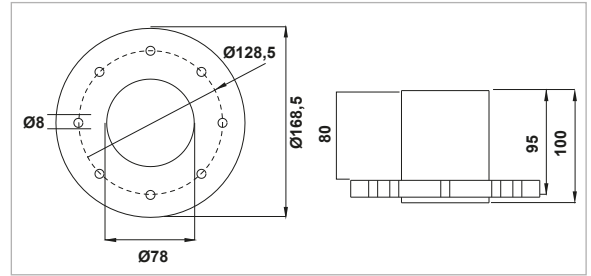

FLANŞ (260)

- Tip: İşlenmemiş
- Flanş Malzemesi: Döküm
- Göbek Tipi: Plastik
- Pervane Tipi: Dragon 260



FLANGE

- Type: Not Machined
- Flange Material: Cast Iron
- Hub Type: Plastic
- Fan Type: Dragon 260

KOD - CODE - CÓDIGO

08110004

BRIDA

- Tipo: No mecanizado
- Material: Hierro fundido
- Tipo de Núcleo: Plástico
- Tipo de Ventilador: Dragon 260

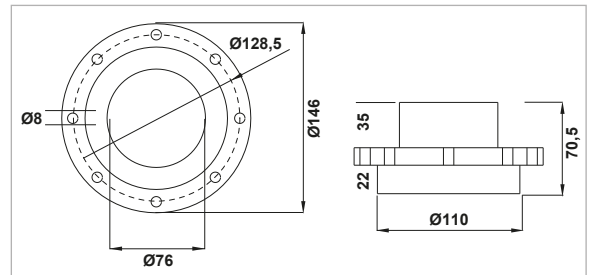

FLANŞ (KISA - 250)

- Tip: İşlenmemiş
- Flanş Malzemesi: Alüminyum
- Göbek Tipi: Alüminyum
- Pervane Tipi: Anemos 250 / Vento 250
Tornado 250



FLANGE

- Type: Not Machined
- Flange Material: Aluminium
- Hub Type: Aluminium
- Fan Type: Anemos 250 / Vento 250
Tornado 250

KOD - CODE - CÓDIGO

08110010

BRIDA

- Tipo: No mecanizado
- Material: Aluminio
- Tipo de Núcleo: Aluminio
- Tipo de Ventilador: Anemos 250 / Vento 250
Tornado 250

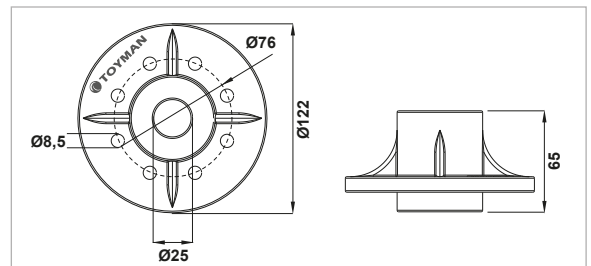

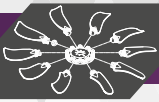

FLANŞ (UZUN - 250)

- Tip: İşlenmemiş
- Flanş Malzemesi: Alüminyum
- Göbek Tipi: Alüminyum
- Pervane Tipi: Anemos 250 / Vento 250 Tornado 250



FLANGE

- Type: Not Machined
- Flange Material: Aluminium
- Hub Type: Aluminium
- Fan Type: Anemos 250 / Vento 250 Tornado 250

KOD - CODE - CÓDIGO

08110011

BRIDA

- Tipo: No mecanizado
- Material: Aluminio
- Tipo de Núcleo: Aluminio
- Tipo de Ventilador: Anemos 250 / Vento 250 Tornado 250

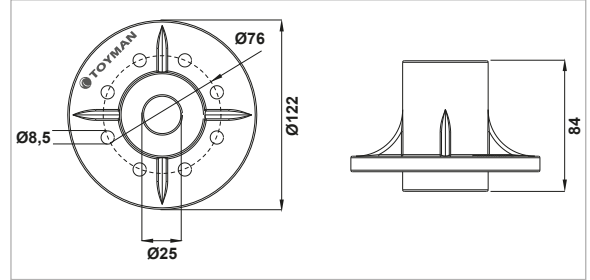

FLANŞ (DÜZ KISA - İ250)

- Tip: İşlenmiş
- Flanş Malzemesi: Alüminyum
- Göbek Tipi: Alüminyum
- Pervane Tipi: Anemos 250 / Vento 250 Tornado 250
- Şanzıman Tipi: Comer D27 9.727.386 (Düz - Kısa)



FLANGE

- Type: Machined
- Flange Material: Aluminium
- Hub Type: Aluminium
- Fan Type: Anemos 250 / Vento 250 Tornado 250
- Gear Box: Comer D27 9.727.386

KOD - CODE - CÓDIGO

08110007

BRIDA

- Tipo: Mecanizado
- Material: Aluminio
- Tipo de Núcleo: Aluminio
- Tipo de Ventilador: Anemos 250 / Vento 250 Tornado 250
- Caja de engranaje: Comer D27 9.727.386

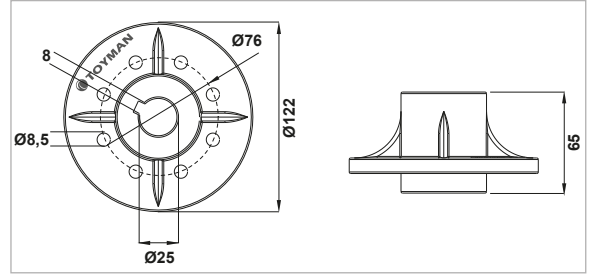

FLANŞ (DÜZ UZUN - İ250)

- Tip: İşlenmiş
- Flanş Malzemesi: Alüminyum
- Göbek Tipi: Alüminyum
- Pervane Tipi: Anemos 250 / Vento 250 Tornado 250
- Şanzıman Tipi: Comer D27 9.727.390 (Düz - Uzun)



FLANGE

- Type: Machined
- Flange Material: Aluminium
- Hub Type: Aluminium
- Fan Type: Anemos 250 / Vento 250 Tornado 250
- Gear Box: Comer D27 9.727.390

KOD - CODE - CÓDIGO

08110008

BRIDA

- Tipo: Mecanizado
- Material: Aluminio
- Tipo de Núcleo: Aluminio
- Tipo de Ventilador: Anemos 250 / Vento 250 Tornado 250
- Caja de engranaje: Comer D27 9.727.390

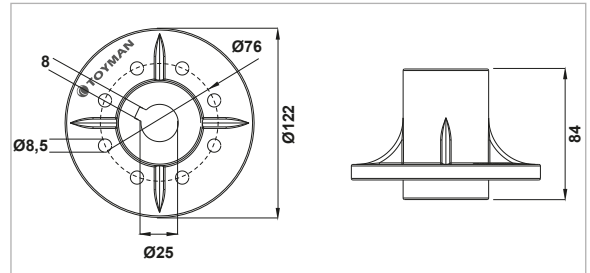

FLANŞ (KONİK - İ250)

- Tip: İşlenmiş
- Flanş Malzemesi: Alüminyum
- Göbek Tipi: Alüminyum
- Pervane Tipi: Anemos 250 / Vento 250 Tornado 250
- Şanzıman Tipi: Comer D27 9.727.00030 (Konik Uzun)



FLANGE

- Type: Machined
- Flange Material: Aluminium
- Hub Type: Aluminium
- Fan Type: Anemos 250 / Vento 250 Tornado 250
- Gear Box: Comer D27 9.727.00030

KOD - CODE - CÓDIGO

08110009

BRIDA

- Tipo: Mecanizado
- Material: Aluminio
- Tipo de Núcleo: Aluminio
- Tipo de Ventilador: Anemos 250 / Vento 250 Tornado 250
- Caja de engranaje: Comer D27 9.727.00030

