



2A

DÜŞÜK BASINÇ KUMANDA ÜNİTELERİ

LOW PRESSURE CONTROL UNITS

GRUPOS DE MANDO DE BAJA PRESIÓN

UMAY SERİSİ / UMAP SERIES / SERIE UMAP

UMAY - SFLB ELEKTRİKLİ
ORANSAL KUMANDA ÜNİTELERİ

- Elektrik ile kumanda edilen ve geri dönüş kalibrasyonlu hat vanaları
- Elektrik ile kumanda edilen ana kontrol vanası
- Ayarlanabilir basınç regülatörü
- Elektrik ile ayarlanabilen oransal vana - 7 saniye
- Segmanlı hat filtresi
- Elektromanyetik debimetre

UMAY - SFLB ELECTRIC
PROPORTIONAL CONTROL UNITS

- Electric section valves with by pass calibration
- Electric main control valve
- Adjustable pressure regulator
- Electric proportional valve - 7 seconds
- Line filter with fork couplings
- Electromagnetic flowmeter

UMAY - SFLB GRUPO
ELÉCTRICO PROPORCIONAL

- Válvulas de sección eléctricas con calibración por by-pass
- Válvula de control principal eléctrica
- Regulador de presión ajustable
- Válvula proporcional eléctrica - 7 segundos
- Filtro de línea con acoplamientos de horquilla
- Caudalímetro electromagnético

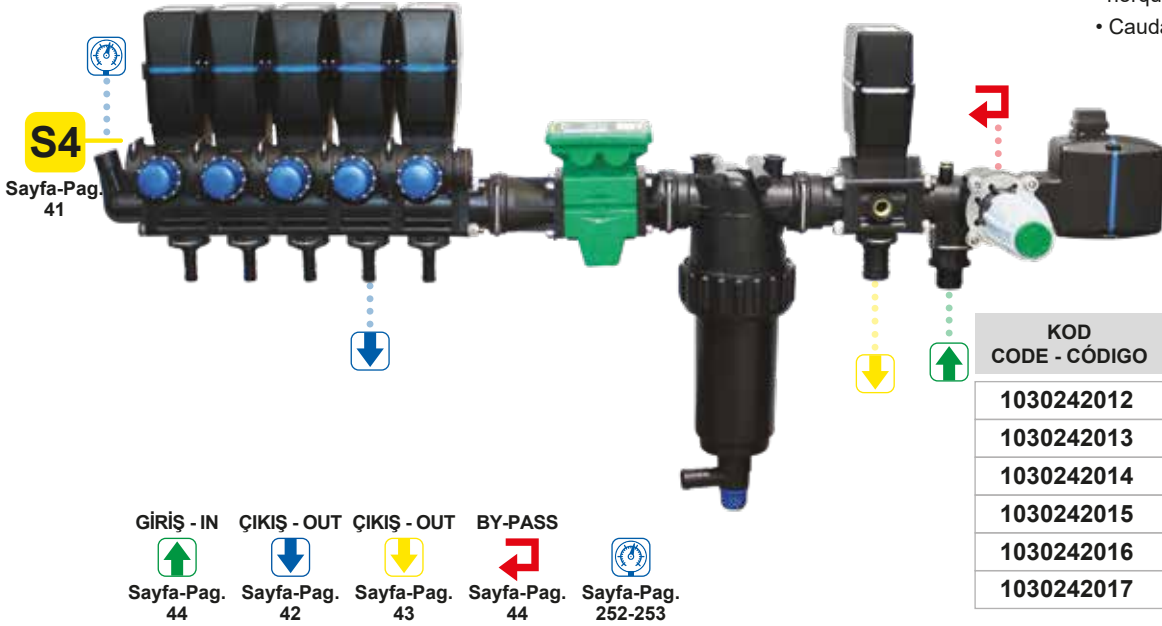

KOD CODE - CÓDIGO	Çıkış Ways - Vías	lt/min	Bar
1030242012	2	180	20
1030242013	3		
1030242014	4		
1030242015	5		
1030242016	6		
1030242017	7		

UMAY - SK ELEKTRİKLİ
ORANSAL KUMANDA ÜNİTELERİ

- Elektrik ile kumanda edilen ve geri dönüş kalibrasyonlu hat vanaları
- Elektrik ile kumanda edilen ana kontrol vanası
- Ayarlanabilir basınç regülatörü
- Elektrik ile ayarlanabilen oransal vana - 14 saniye
- Segmanlı hat filtresi

UMAY - SK ELECTRIC
PROPORTIONAL CONTROL UNITS

- Electric section valves with by pass calibration
- Electric main control valve
- Adjustable pressure regulator
- Electric proportional valve - 14 seconds
- Line filter with fork couplings

UMAY - SK GRUPO
ELÉCTRICO PROPORCIONAL

- Válvulas de sección eléctricas con calibración por by-pass
- Válvula de control principal eléctrica
- Regulador de presión ajustable
- Válvula proporcional eléctrica - 14 segundos
- Filtro de línea con acoplamientos de horquilla

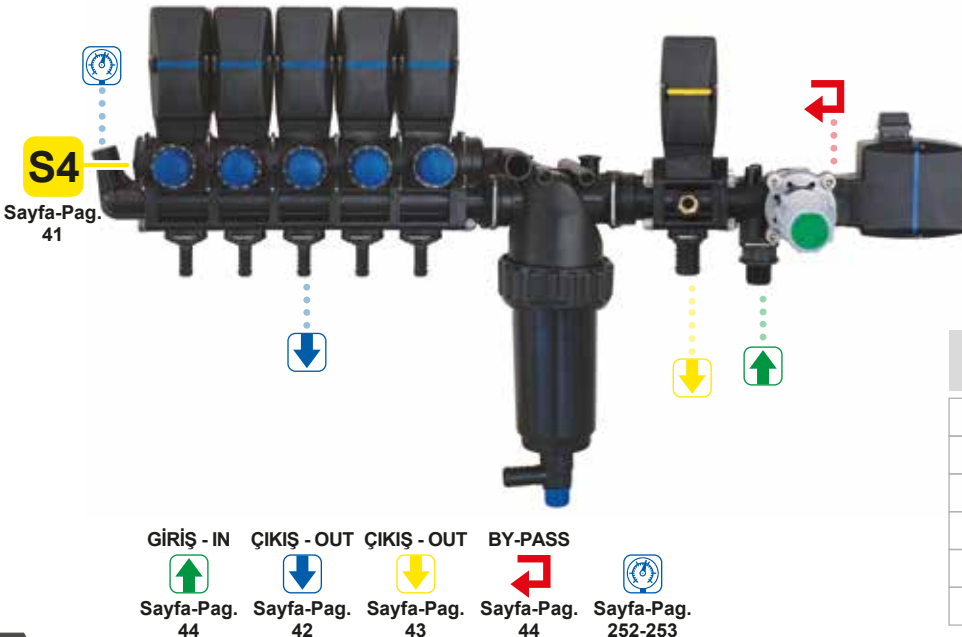

KOD CODE - CÓDIGO	Çıkış Ways - Vías	lt/min	Bar
1030252012	2	180	20
1030252013	3		
1030252014	4		
1030252015	5		
1030252016	6		
1030252017	7		

UMAY SERİSİ / UMA SERIES / SERIE UMA

UMAY KİT 1

UMAY KİT 1

UMAY KİT 1

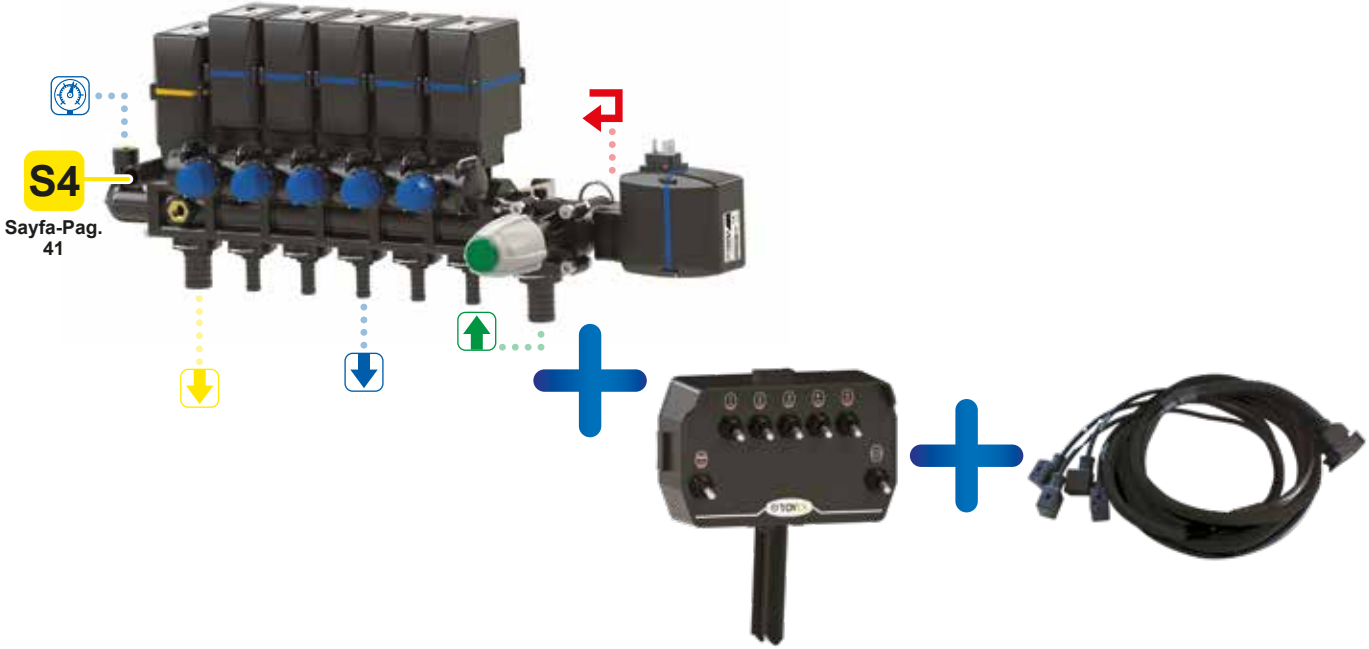

GİRİŞ - IN ÇIKIŞ - OUT ÇIKIŞ - OUT BY-PASS

Sayfa-Pag.
44Sayfa-Pag.
42Sayfa-Pag.
43Sayfa-Pag.
44Sayfa-Pag.
252-253

KOD CODE - CÓDIGO	Çıkış Ways - Vias	lt/min	Bar
1030151805OC	5	180	20

UMAY KİT 2

UMAY KİT 2

UMAY KİT 2

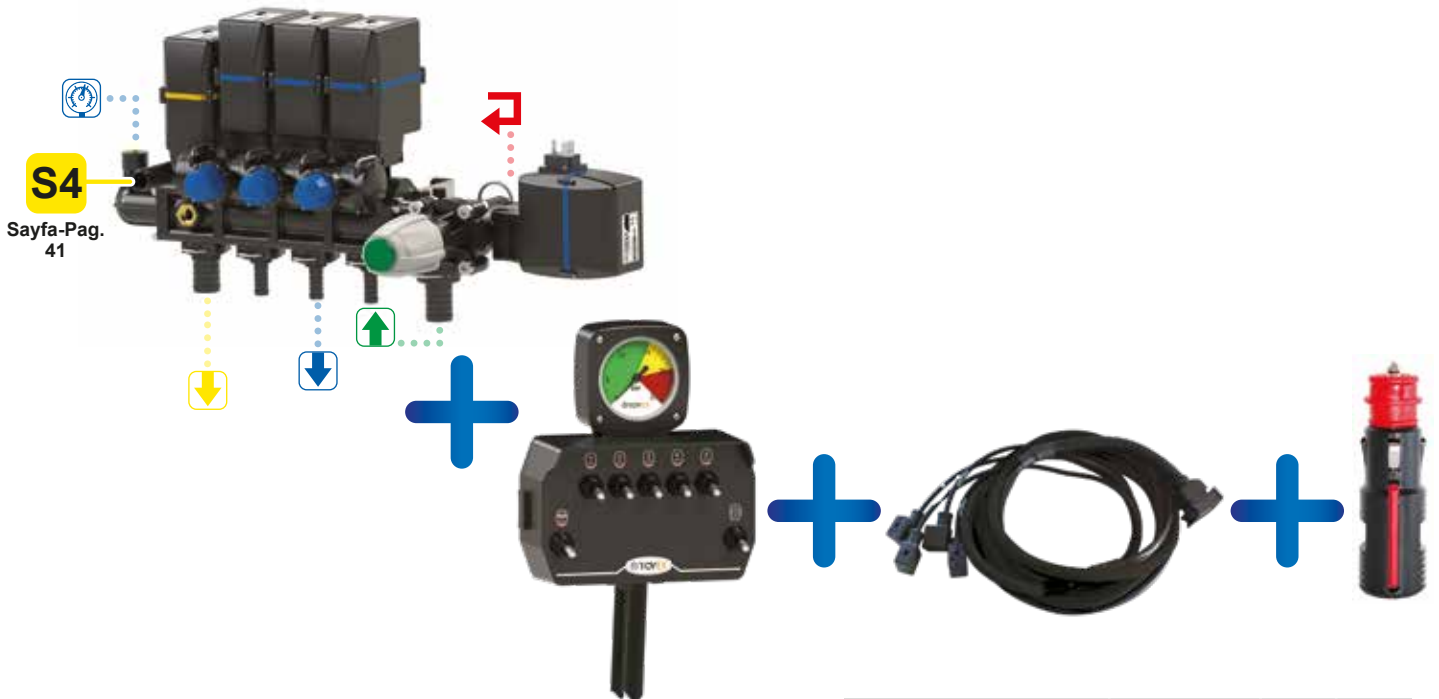

GİRİŞ - IN ÇIKIŞ - OUT ÇIKIŞ - OUT BY-PASS

Sayfa-Pag.
44Sayfa-Pag.
42Sayfa-Pag.
43Sayfa-Pag.
44Sayfa-Pag.
252-253

KOD CODE - CÓDIGO	Çıkış Ways - Vias	lt/min	Bar
1030151803OCS	3	180	20
1030151805OCS	5		

UMAY SERİSİ / UMAP SERIES / SERIE UMAP

UMAY - PC ELEKTRİKLİ
ORANSAL KUMANDA ÜNİTELERİ

- Elektrik ile kumanda edilen ve geri dönüş kalibrasyonlu hat vanaları
- Elektrik ile kumanda edilen ana kontrol vanası
- Ayarlanabilir basınç regülatörü
- Elektrik ile ayarlanabilen oransal vana

UMAY - PC ELECTRIC
PROPORTIONAL CONTROL UNITS

- Electric section valves with by-pass calibration
- Electric main control valve
- Adjustable pressure regulator
- Electric proportional valve

UMAY - PC GRUPO
ELÉCTRICO PROPORCIONAL

- Válvulas de sección eléctrica con calibración por by-pass
- Válvula de control principal eléctrica
- Regulador de presión ajustable
- Válvula proporcional eléctrica

UMAY - PC 02

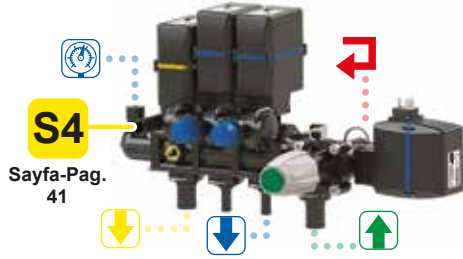

KOD CODE - CÓDIGO	Çıkış Ways - Vias	lt/min	Bar
1030151802	2	180	20

GİRİŞ - IN	ÇIKIŞ - OUT	ÇIKIŞ - OUT	BY-PASS	
Sayfa-Pag. 44	Sayfa-Pag. 42	Sayfa-Pag. 43	Sayfa-Pag. 44	Sayfa-Pag. 252-253

UMAY - PC 03

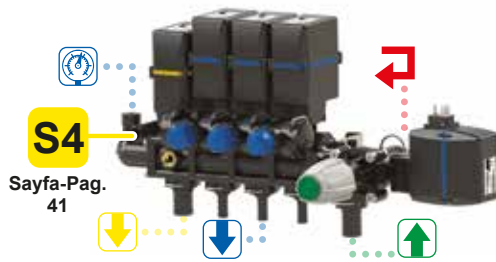

KOD CODE - CÓDIGO	Çıkış Ways - Vias	lt/min	Bar
1030151803	3	180	20

GİRİŞ - IN	ÇIKIŞ - OUT	ÇIKIŞ - OUT	BY-PASS	
Sayfa-Pag. 44	Sayfa-Pag. 42	Sayfa-Pag. 43	Sayfa-Pag. 44	Sayfa-Pag. 252-253

UMAY - PC 04



KOD CODE - CÓDIGO	Çıkış Ways - Vias	lt/min	Bar
1030151804	4	180	20

GİRİŞ - IN	ÇIKIŞ - OUT	ÇIKIŞ - OUT	BY-PASS	
Sayfa-Pag. 44	Sayfa-Pag. 42	Sayfa-Pag. 43	Sayfa-Pag. 44	Sayfa-Pag. 252-253

UMAY - PC 05



KOD CODE - CÓDIGO	Çıkış Ways - Vias	lt/min	Bar
1030151805	5	180	20

GİRİŞ - IN	ÇIKIŞ - OUT	ÇIKIŞ - OUT	BY-PASS	
Sayfa-Pag. 44	Sayfa-Pag. 42	Sayfa-Pag. 43	Sayfa-Pag. 44	Sayfa-Pag. 252-253

UMAY - PC 06



KOD CODE - CÓDIGO	Çıkış Ways - Vias	lt/min	Bar
1030151806	6	180	20

GİRİŞ - IN	ÇIKIŞ - OUT	ÇIKIŞ - OUT	BY-PASS	
Sayfa-Pag. 44	Sayfa-Pag. 42	Sayfa-Pag. 43	Sayfa-Pag. 44	Sayfa-Pag. 252-253

UMAY - PC 07



KOD CODE - CÓDIGO	Çıkış Ways - Vias	lt/min	Bar
1030151807	7	180	20

GİRİŞ - IN	ÇIKIŞ - OUT	ÇIKIŞ - OUT	BY-PASS	
Sayfa-Pag. 44	Sayfa-Pag. 42	Sayfa-Pag. 43	Sayfa-Pag. 44	Sayfa-Pag. 252-253

UMAY SERİSİ / UMay SERIES / SERIE UMay

UMAY - PCF ELEKTRİKLİ
ORANSAL KUMANDA ÜNİTELERİ

- Elektrik ile kumanda edilen ve geri dönüş kalibrasyonlu hat vanaları
- Elektrik ile kumanda edilen ana kontrol vanası
- Ayarlanabilir basınç regülatörü
- Elektrik ile ayarlanabilen oransal vana
- Hat filtresi

UMAY - PCF ELECTRIC
PROPORTIONAL CONTROL UNITS

- Electric section valves with by-pass calibration
- Electric main control valve
- Adjustable pressure regulator
- Electric proportional valve
- Line filter

UMAY - PCF GRUPO
ELÉCTRICO PROPORCIONAL

- Válvulas de sección eléctricas con calibración por by-pass
- Válvula de control principal eléctrica
- Regulador de presión ajustable
- Válvula proporcional eléctrica
- Filtro de línea

UMAY - PCF 02

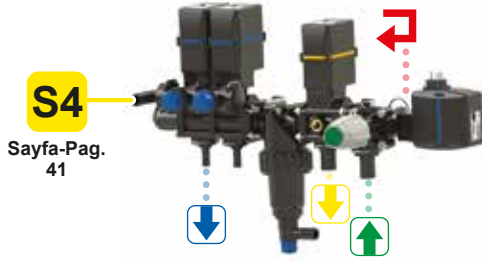

KOD CODE - CÓDIGO	Çıkış Ways - Vias	lt/min	Bar
1030151812	2	180	20

GİRİŞ - IN	ÇIKIŞ - OUT	ÇIKIŞ - OUT	BY-PASS
Sayfa-Pag. 44	Sayfa-Pag. 42	Sayfa-Pag. 43	Sayfa-Pag. 44

UMAY - PCF 03

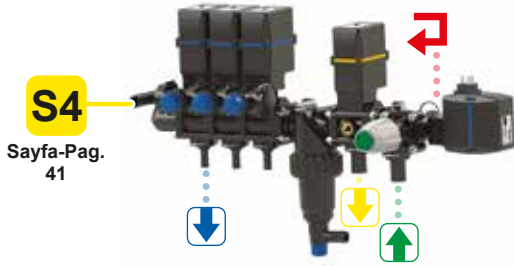

KOD CODE - CÓDIGO	Çıkış Ways - Vias	lt/min	Bar
1030151813	3	180	20

GİRİŞ - IN	ÇIKIŞ - OUT	ÇIKIŞ - OUT	BY-PASS
Sayfa-Pag. 44	Sayfa-Pag. 42	Sayfa-Pag. 43	Sayfa-Pag. 44

UMAY - PCF 04

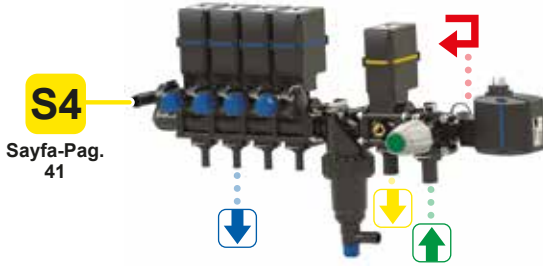

KOD CODE - CÓDIGO	Çıkış Ways - Vias	lt/min	Bar
1030151814	4	180	20

GİRİŞ - IN	ÇIKIŞ - OUT	ÇIKIŞ - OUT	BY-PASS
Sayfa-Pag. 44	Sayfa-Pag. 42	Sayfa-Pag. 43	Sayfa-Pag. 44

UMAY - PCF 05

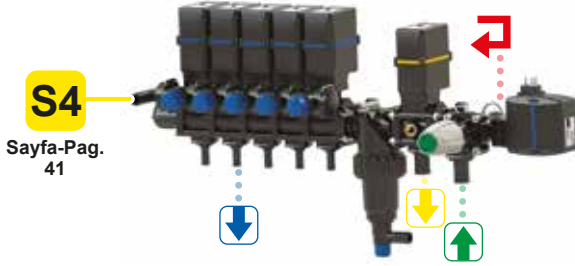

KOD CODE - CÓDIGO	Çıkış Ways - Vias	lt/min	Bar
1030151815	5	180	20

GİRİŞ - IN	ÇIKIŞ - OUT	ÇIKIŞ - OUT	BY-PASS
Sayfa-Pag. 44	Sayfa-Pag. 42	Sayfa-Pag. 43	Sayfa-Pag. 44

UMAY - PCF 06



KOD CODE - CÓDIGO	Çıkış Ways - Vias	lt/min	Bar
1030151816	6	180	20

GİRİŞ - IN	ÇIKIŞ - OUT	ÇIKIŞ - OUT	BY-PASS
Sayfa-Pag. 44	Sayfa-Pag. 42	Sayfa-Pag. 43	Sayfa-Pag. 44

UMAY - PCF 07

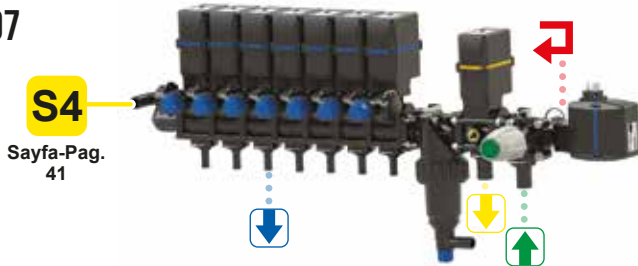

KOD CODE - CÓDIGO	Çıkış Ways - Vias	lt/min	Bar
1030151817	7	180	20

GİRİŞ - IN	ÇIKIŞ - OUT	ÇIKIŞ - OUT	BY-PASS
Sayfa-Pag. 44	Sayfa-Pag. 42	Sayfa-Pag. 43	Sayfa-Pag. 44

CERES SERİSİ / CERES SERIES / SERIE CERES

CERES - M SABİT
BASINÇ KUMANDA ÜNİTELERİ

- El ile kumanda edilen hat vanaları
- El ile kumanda edilen ana kontrol vanası
- Ayarlanabilir basınç regülatörü

CERES - M CONSTANT
PRESSURE CONTROL UNITS

- Manual section valves
- Manual main control valve
- Adjustable pressure regulator

CERES - M GRUPO MANUAL
DE PRESIÓN CONSTANTE

- Válvulas de sección manuales
- Válvula de control principal manual
- Regulador de presión ajustable

CERES - M 02

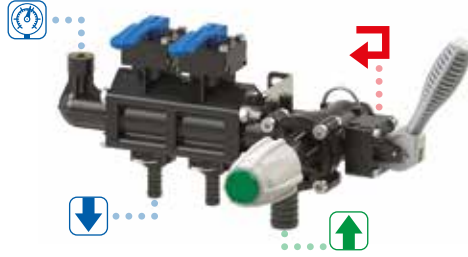

KOD CODE - CÓDIGO	Çıkış Ways - Vias	lt/min	Bar
1030111802	2	180	20

GİRİŞ - IN ÇIKIŞ - OUT BY-PASS

Sayfa-Pag. 44	Sayfa-Pag. 42	Sayfa-Pag. 44	Sayfa-Pag. 252-253

CERES - M 03



KOD CODE - CÓDIGO	Çıkış Ways - Vias	lt/min	Bar
1030111803	3	180	20

GİRİŞ - IN ÇIKIŞ - OUT BY-PASS

Sayfa-Pag. 44	Sayfa-Pag. 42	Sayfa-Pag. 44	Sayfa-Pag. 252-253

CERES - M 04



KOD CODE - CÓDIGO	Çıkış Ways - Vias	lt/min	Bar
1030111804	4	180	20

GİRİŞ - IN ÇIKIŞ - OUT BY-PASS

Sayfa-Pag. 44	Sayfa-Pag. 42	Sayfa-Pag. 44	Sayfa-Pag. 252-253

CERES - M 05



KOD CODE - CÓDIGO	Çıkış Ways - Vias	lt/min	Bar
1030111805	5	180	20

GİRİŞ - IN ÇIKIŞ - OUT BY-PASS

Sayfa-Pag. 44	Sayfa-Pag. 42	Sayfa-Pag. 44	Sayfa-Pag. 252-253

CERES - M 06



KOD CODE - CÓDIGO	Çıkış Ways - Vias	lt/min	Bar
1030111806	6	180	20

GİRİŞ - IN ÇIKIŞ - OUT BY-PASS

Sayfa-Pag. 44	Sayfa-Pag. 42	Sayfa-Pag. 44	Sayfa-Pag. 252-253

CERES - M 07



KOD CODE - CÓDIGO	Çıkış Ways - Vias	lt/min	Bar
1030111807	7	180	20

GİRİŞ - IN ÇIKIŞ - OUT BY-PASS

Sayfa-Pag. 44	Sayfa-Pag. 42	Sayfa-Pag. 44	Sayfa-Pag. 252-253

CERES SERİSİ / CERES SERIES / SERIE CERES

CERES - E SABİT
BASINÇ KUMANDA ÜNİTELERİ

- El ile kumanda edilen hat vanaları
- Elektrik ile kumanda edilen ana kontrol vanası
- Ayarlanabilir basınç regülatörü

CERES - E CONSTANT
PRESSURE CONTROL UNITS

- Manual section valves
- Electric main control valve
- Adjustable pressure regulator

CERES - E GRUPO MANUAL
DE PRESIÓN CONSTANTE

- Válvulas de sección manuales
- Válvula de control principal eléctrica
- Regulador de presión ajustable

CERES - E 02

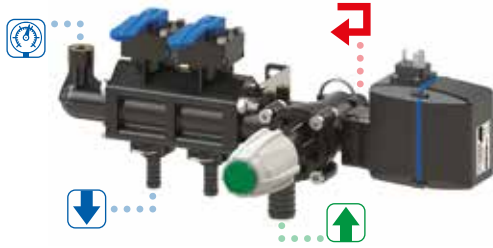

KOD CODE - CÓDIGO	Çıkış Ways - Vias	lt/min	Bar
1030121802	2	180	20

GİRİŞ - IN	ÇIKIŞ - OUT	BY-PASS	
Sayfa-Pag. 44	Sayfa-Pag. 42	Sayfa-Pag. 44	Sayfa-Pag. 252-253

CERES - E 03

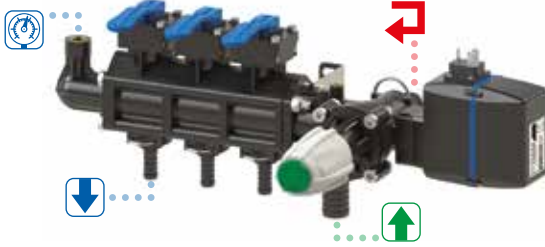

KOD CODE - CÓDIGO	Çıkış Ways - Vias	lt/min	Bar
1030121803	3	180	20

GİRİŞ - IN	ÇIKIŞ - OUT	BY-PASS	
Sayfa-Pag. 44	Sayfa-Pag. 42	Sayfa-Pag. 44	Sayfa-Pag. 252-253

CERES - E 04



KOD CODE - CÓDIGO	Çıkış Ways - Vias	lt/min	Bar
1030121804	4	180	20

GİRİŞ - IN	ÇIKIŞ - OUT	BY-PASS	
Sayfa-Pag. 44	Sayfa-Pag. 42	Sayfa-Pag. 44	Sayfa-Pag. 252-253

CERES - E 05



KOD CODE - CÓDIGO	Çıkış Ways - Vias	lt/min	Bar
1030121805	5	180	20

GİRİŞ - IN	ÇIKIŞ - OUT	BY-PASS	
Sayfa-Pag. 44	Sayfa-Pag. 42	Sayfa-Pag. 44	Sayfa-Pag. 252-253

CERES - E 06



KOD CODE - CÓDIGO	Çıkış Ways - Vias	lt/min	Bar
1030121806	6	180	20

GİRİŞ - IN	ÇIKIŞ - OUT	BY-PASS	
Sayfa-Pag. 44	Sayfa-Pag. 42	Sayfa-Pag. 44	Sayfa-Pag. 252-253

CERES - E 07



KOD CODE - CÓDIGO	Çıkış Ways - Vias	lt/min	Bar
1030121807	7	180	20

GİRİŞ - IN	ÇIKIŞ - OUT	BY-PASS	
Sayfa-Pag. 44	Sayfa-Pag. 42	Sayfa-Pag. 44	Sayfa-Pag. 252-253

CERES SERİSİ / CERES SERIES / SERIE CERES

CERES - MF SABİT
BASINÇ KUMANDA ÜNİTELERİ

- El ile kumanda edilen hat vanaları
- El ile kumanda edilen ana kontrol vanası
- Ayarlanabilir basınç regülatörü
- Hat filtresi

CERES - MF CONSTANT
PRESSURE CONTROL UNITS

- Manual section valves
- Manual main control valve
- Adjustable pressure regulator
- Line filter

CERES - MF GRUPO MANUAL
DE PRESIÓN CONSTANTE

- Válvulas de sección manuales
- Válvula de control principal manual
- Regulador de presión ajustable
- Filtro de línea

CERES - MF 02



KOD CODE - CÓDIGO	Çıkış Ways - Vias	lt/min	Bar
1030111812	2	180	20

GİRİŞ - IN ÇIKIŞ - OUT BY-PASS

Sayfa-Pag.
44Sayfa-Pag.
42Sayfa-Pag.
44Sayfa-Pag.
252-253

CERES - MF 03



KOD CODE - CÓDIGO	Çıkış Ways - Vias	lt/min	Bar
1030111813	3	180	20

GİRİŞ - IN ÇIKIŞ - OUT BY-PASS

Sayfa-Pag.
44Sayfa-Pag.
42Sayfa-Pag.
44Sayfa-Pag.
252-253

CERES - MF 04



KOD CODE - CÓDIGO	Çıkış Ways - Vias	lt/min	Bar
1030111814	4	180	20

GİRİŞ - IN ÇIKIŞ - OUT BY-PASS

Sayfa-Pag.
44Sayfa-Pag.
42Sayfa-Pag.
44Sayfa-Pag.
252-253

CERES - MF 05



KOD CODE - CÓDIGO	Çıkış Ways - Vias	lt/min	Bar
1030111815	5	180	20

GİRİŞ - IN ÇIKIŞ - OUT BY-PASS

Sayfa-Pag.
44Sayfa-Pag.
42Sayfa-Pag.
44Sayfa-Pag.
252-253

CERES - MF 06



KOD CODE - CÓDIGO	Çıkış Ways - Vias	lt/min	Bar
1030111816	6	180	20

GİRİŞ - IN ÇIKIŞ - OUT BY-PASS

Sayfa-Pag.
44Sayfa-Pag.
42Sayfa-Pag.
44Sayfa-Pag.
252-253

CERES - MF 07



KOD CODE - CÓDIGO	Çıkış Ways - Vias	lt/min	Bar
1030111817	7	180	20

GİRİŞ - IN ÇIKIŞ - OUT BY-PASS

Sayfa-Pag.
44Sayfa-Pag.
42Sayfa-Pag.
44Sayfa-Pag.
252-253

CERES SERİSİ / CERES SERIES / SERIE CERES

CERES - EF SABİT
BASINÇ KUMANDA ÜNİTELERİ

- El ile kumanda edilen hat vanaları
- Elektrik ile kumanda edilen ana kontrol vanası
- Ayarlanabilir basınç regülatörü
- Hat filtresi

CERES - EF CONSTANT
PRESSURE CONTROL UNITS

- Manual section valves
- Electric main control valve
- Adjustable pressure regulator
- Line filter

CERES - EF GRUPO MANUAL
DE PRESIÓN CONSTANTE

- Válvulas de sección manuales
- Válvula de control principal eléctrica
- Regulador de presión ajustable
- Filtro de línea

CERES - EF 02

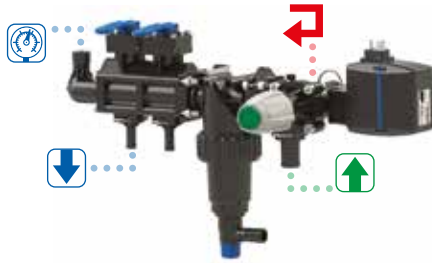

KOD CODE - CÓDIGO	Çıkış Ways - Vias	lt/min	Bar
1030121812	2	180	20

GİRİŞ - IN	ÇIKIŞ - OUT	BY-PASS	
Sayfa-Pag. 44	Sayfa-Pag. 42	Sayfa-Pag. 44	Sayfa-Pag. 252-253

CERES - EF 03



KOD CODE - CÓDIGO	Çıkış Ways - Vias	lt/min	Bar
1030121813	3	180	20

GİRİŞ - IN	ÇIKIŞ - OUT	BY-PASS	
Sayfa-Pag. 44	Sayfa-Pag. 42	Sayfa-Pag. 44	Sayfa-Pag. 252-253

CERES - EF 04

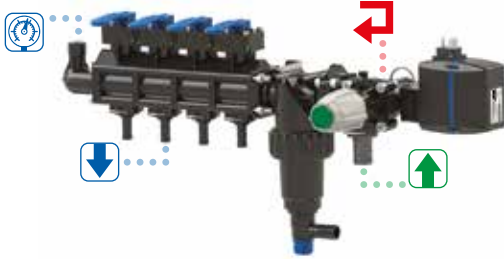

KOD CODE - CÓDIGO	Çıkış Ways - Vias	lt/min	Bar
1030121814	4	180	20

GİRİŞ - IN	ÇIKIŞ - OUT	BY-PASS	
Sayfa-Pag. 44	Sayfa-Pag. 42	Sayfa-Pag. 44	Sayfa-Pag. 252-253

CERES - EF 05



KOD CODE - CÓDIGO	Çıkış Ways - Vias	lt/min	Bar
1030121815	5	180	20

GİRİŞ - IN	ÇIKIŞ - OUT	BY-PASS	
Sayfa-Pag. 44	Sayfa-Pag. 42	Sayfa-Pag. 44	Sayfa-Pag. 252-253

CERES - EF 06



KOD CODE - CÓDIGO	Çıkış Ways - Vias	lt/min	Bar
1030121816	6	180	20

GİRİŞ - IN	ÇIKIŞ - OUT	BY-PASS	
Sayfa-Pag. 44	Sayfa-Pag. 42	Sayfa-Pag. 44	Sayfa-Pag. 252-253

CERES - EF 07



KOD CODE - CÓDIGO	Çıkış Ways - Vias	lt/min	Bar
1030121817	7	180	20

GİRİŞ - IN	ÇIKIŞ - OUT	BY-PASS	
Sayfa-Pag. 44	Sayfa-Pag. 42	Sayfa-Pag. 44	Sayfa-Pag. 252-253

CERES SERİSİ / CERES SERIES / SERIE CERES

CERES - MPC ORANSAL
KUMANDA ÜNİTELERİ

- El ile kumanda edilen ve geri dönüş kalibrasyonlu hat vanaları
- El ile kumanda edilen ana kontrol vanası
- Ayarlanabilir basınç regülatörü
- El ile ayarlanabilen oransal vana

CERES - MPC PROPORTIONAL
CONTROL UNITS

- Manual section valves with by-pass calibration
- Manual main control valve
- Adjustable pressure regulator
- Manual proportional valve

CERES - MPC GRUPO
MANUAL PROPORCIONAL

- Válvulas de sección manuales con calibración por by-pass
- Válvula de control principal manual
- Regulador de presión ajustable
- Válvula proporcional manual

CERES - MPC 02

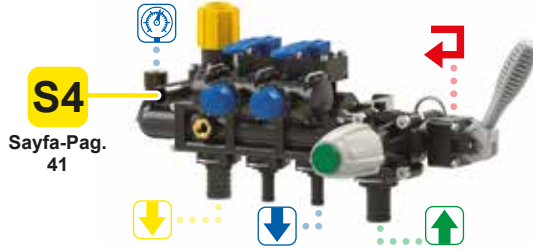

S4
Sayfa-Pag.
41

KOD CODE - CÓDIGO	Çıkış Ways - Vias	lt/min	Bar
1030131802	2	180	20

GİRİŞ - IN	ÇIKIŞ - OUT	ÇIKIŞ - OUT	BY-PASS	
Sayfa-Pag. 44	Sayfa-Pag. 42	Sayfa-Pag. 43	Sayfa-Pag. 44	Sayfa-Pag. 252-253

CERES - MPC 03

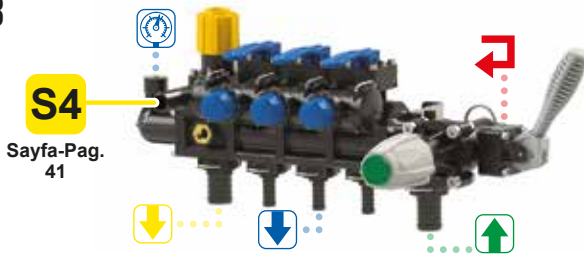

S4
Sayfa-Pag.
41

KOD CODE - CÓDIGO	Çıkış Ways - Vias	lt/min	Bar
1030131803	3	180	20

GİRİŞ - IN	ÇIKIŞ - OUT	ÇIKIŞ - OUT	BY-PASS	
Sayfa-Pag. 44	Sayfa-Pag. 42	Sayfa-Pag. 43	Sayfa-Pag. 44	Sayfa-Pag. 252-253

CERES - MPC 04



S4
Sayfa-Pag.
41

KOD CODE - CÓDIGO	Çıkış Ways - Vias	lt/min	Bar
1030131804	4	180	20

GİRİŞ - IN	ÇIKIŞ - OUT	ÇIKIŞ - OUT	BY-PASS	
Sayfa-Pag. 44	Sayfa-Pag. 42	Sayfa-Pag. 43	Sayfa-Pag. 44	Sayfa-Pag. 252-253

CERES - MPC 05



S4
Sayfa-Pag.
41

KOD CODE - CÓDIGO	Çıkış Ways - Vias	lt/min	Bar
1030131805	5	180	20

GİRİŞ - IN	ÇIKIŞ - OUT	ÇIKIŞ - OUT	BY-PASS	
Sayfa-Pag. 44	Sayfa-Pag. 42	Sayfa-Pag. 43	Sayfa-Pag. 44	Sayfa-Pag. 252-253

CERES - MPC 06



S4
Sayfa-Pag.
41

KOD CODE - CÓDIGO	Çıkış Ways - Vias	lt/min	Bar
1030131806	6	180	20

GİRİŞ - IN	ÇIKIŞ - OUT	ÇIKIŞ - OUT	BY-PASS	
Sayfa-Pag. 44	Sayfa-Pag. 42	Sayfa-Pag. 43	Sayfa-Pag. 44	Sayfa-Pag. 252-253

CERES - MPC 07



S4
Sayfa-Pag.
41

KOD CODE - CÓDIGO	Çıkış Ways - Vias	lt/min	Bar
1030131807	7	180	20

GİRİŞ - IN	ÇIKIŞ - OUT	ÇIKIŞ - OUT	BY-PASS	
Sayfa-Pag. 44	Sayfa-Pag. 42	Sayfa-Pag. 43	Sayfa-Pag. 44	Sayfa-Pag. 252-253

CERES SERİSİ / CERES SERIES / SERIE CERES

CERES - EPC ORANSAL
KUMANDA ÜNİTELERİ

- El ile kumanda edilen ve geri dönüş kalibrasyonlu hat vanaları
- Elektrik ile kumanda edilen ana kontrol vanası
- Ayarlanabilir basınç regülatörü
- El ile ayarlanabilen oransal vana

CERES - EPC PROPORTIONAL
CONTROL UNITS

- Manual section valves with by-pass calibration
- Electric main control valve
- Adjustable pressure regulator
- Manual proportional valve

CERES - EPC GRUPO
MANUAL PROPORCIONAL

- Válvulas de sección manuales con calibración por by-pass
- Válvula de control principal eléctrica
- Regulador de presión ajustable
- Válvula proporcional manual

CERES - EPC 02

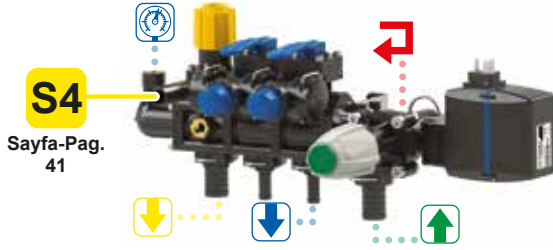
S4
Sayfa-Pag.
41

KOD CODE - CÓDIGO	Çıkış Ways - Vias	lt/min	Bar
1030141802	2	180	20

GİRİŞ - IN	ÇIKIŞ - OUT	ÇIKIŞ - OUT	BY-PASS	
Sayfa-Pag. 44	Sayfa-Pag. 42	Sayfa-Pag. 43	Sayfa-Pag. 44	Sayfa-Pag. 252-253

CERES - EPC 03

S4
Sayfa-Pag.
41

KOD CODE - CÓDIGO	Çıkış Ways - Vias	lt/min	Bar
1030141803	3	180	20

GİRİŞ - IN	ÇIKIŞ - OUT	ÇIKIŞ - OUT	BY-PASS	
Sayfa-Pag. 44	Sayfa-Pag. 42	Sayfa-Pag. 43	Sayfa-Pag. 44	Sayfa-Pag. 252-253

CERES - EPC 04

S4
Sayfa-Pag.
41

KOD CODE - CÓDIGO	Çıkış Ways - Vias	lt/min	Bar
1030141804	4	180	20

GİRİŞ - IN	ÇIKIŞ - OUT	ÇIKIŞ - OUT	BY-PASS	
Sayfa-Pag. 44	Sayfa-Pag. 42	Sayfa-Pag. 43	Sayfa-Pag. 44	Sayfa-Pag. 252-253

CERES - EPC 05

S4
Sayfa-Pag.
41

KOD CODE - CÓDIGO	Çıkış Ways - Vias	lt/min	Bar
1030141805	5	180	20

GİRİŞ - IN	ÇIKIŞ - OUT	ÇIKIŞ - OUT	BY-PASS	
Sayfa-Pag. 44	Sayfa-Pag. 42	Sayfa-Pag. 43	Sayfa-Pag. 44	Sayfa-Pag. 252-253

CERES - EPC 06

S4
Sayfa-Pag.
41

KOD CODE - CÓDIGO	Çıkış Ways - Vias	lt/min	Bar
1030141806	6	180	20

GİRİŞ - IN	ÇIKIŞ - OUT	ÇIKIŞ - OUT	BY-PASS	
Sayfa-Pag. 44	Sayfa-Pag. 42	Sayfa-Pag. 43	Sayfa-Pag. 44	Sayfa-Pag. 252-253

CERES - EPC 07

S4
Sayfa-Pag.
41

KOD CODE - CÓDIGO	Çıkış Ways - Vias	lt/min	Bar
1030141807	7	180	20

GİRİŞ - IN	ÇIKIŞ - OUT	ÇIKIŞ - OUT	BY-PASS	
Sayfa-Pag. 44	Sayfa-Pag. 42	Sayfa-Pag. 43	Sayfa-Pag. 44	Sayfa-Pag. 252-253

CERES SERİSİ / CERES SERIES / SERIE CERES

CERES - MPCF ORANSAL
KUMANDA ÜNİTELERİ

- El ile kumanda edilen ve geri dönüş kalibrasyonlu hat vanaları
- El ile kumanda edilen ana kontrol vanası
- Ayarlanabilir basınç regülatörü
- El ile ayarlanabilen oransal vana
- Hat filtresi

CERES - MPCF PROPORTIONAL
CONTROL UNITS

- Manual section valves with by-pass calibration
- Manual main control valve
- Adjustable pressure regulator
- Manual proportional valve
- Line filter

CERES - MPCF GRUPO
MANUAL PROPORCIONAL

- Válvulas de sección manuales con calibración por by-pass
- Válvula de control principal manual
- Regulador de presión ajustable
- Válvula proporcional manual
- Filtro de línea

CERES - MPCF 02

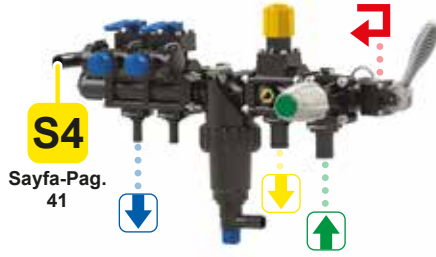

KOD CODE - CÓDIGO	Çıkış Ways - Vias	lt/min	Bar
1030131812	2	180	20

GİRİŞ - IN	ÇIKIŞ - OUT	ÇIKIŞ - OUT	BY-PASS
Sayfa-Pag. 44	Sayfa-Pag. 42	Sayfa-Pag. 43	Sayfa-Pag. 44

CERES - MPCF 03

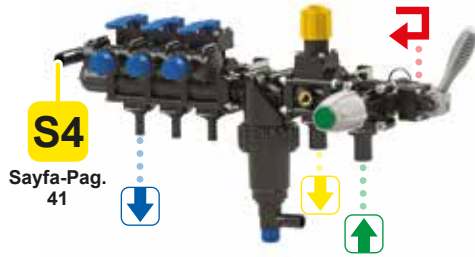

KOD CODE - CÓDIGO	Çıkış Ways - Vias	lt/min	Bar
1030131813	3	180	20

GİRİŞ - IN	ÇIKIŞ - OUT	ÇIKIŞ - OUT	BY-PASS
Sayfa-Pag. 44	Sayfa-Pag. 42	Sayfa-Pag. 43	Sayfa-Pag. 44

CERES - MPCF 04

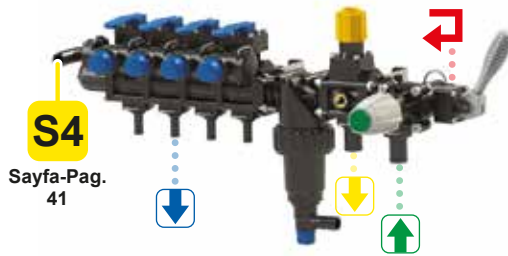

KOD CODE - CÓDIGO	Çıkış Ways - Vias	lt/min	Bar
1030131814	4	180	20

GİRİŞ - IN	ÇIKIŞ - OUT	ÇIKIŞ - OUT	BY-PASS
Sayfa-Pag. 44	Sayfa-Pag. 42	Sayfa-Pag. 43	Sayfa-Pag. 44

CERES - MPCF 05

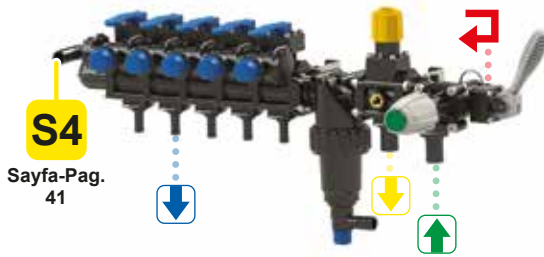

KOD CODE - CÓDIGO	Çıkış Ways - Vias	lt/min	Bar
1030131815	5	180	20

GİRİŞ - IN	ÇIKIŞ - OUT	ÇIKIŞ - OUT	BY-PASS
Sayfa-Pag. 44	Sayfa-Pag. 42	Sayfa-Pag. 43	Sayfa-Pag. 44

CERES - MPCF 06

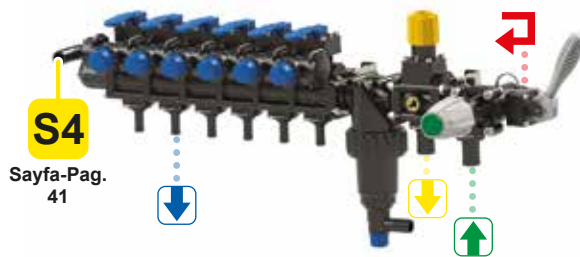

KOD CODE - CÓDIGO	Çıkış Ways - Vias	lt/min	Bar
1030131816	6	180	20

GİRİŞ - IN	ÇIKIŞ - OUT	ÇIKIŞ - OUT	BY-PASS
Sayfa-Pag. 44	Sayfa-Pag. 42	Sayfa-Pag. 43	Sayfa-Pag. 44

CERES - MPCF 07

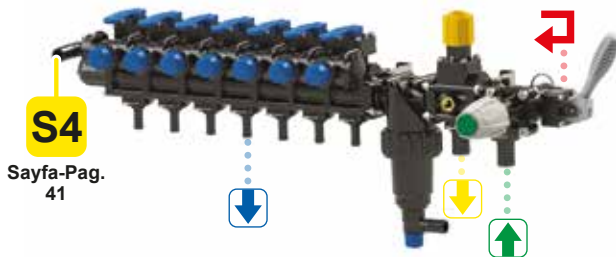

KOD CODE - CÓDIGO	Çıkış Ways - Vias	lt/min	Bar
1030131817	7	180	20

GİRİŞ - IN	ÇIKIŞ - OUT	ÇIKIŞ - OUT	BY-PASS
Sayfa-Pag. 44	Sayfa-Pag. 42	Sayfa-Pag. 43	Sayfa-Pag. 44

CERES SERİSİ / CERES SERIES / SERIE CERES

CERES - EPCF ORANSAL
KUMANDA ÜNİTELERİ

- El ile kumanda edilen ve geri dönüş kalibrasyonlu hat vanaları
- Elektrik ile kumanda edilen ana kontrol vanası
- Ayarlanabilir basınç regülatörü
- El ile ayarlanabilen oransal vana
- Hat filtresi

CERES - EPCF PROPORTIONAL
CONTROL UNITS

- Manual section valves with by-pass calibration
- Electric main control valve
- Adjustable pressure regulator
- Manual proportional valve
- Line filter

CERES - EPCF GRUPO
MANUAL PROPORCIONAL

- Válvulas de sección manuales con calibración por by-pass
- Válvula de control principal eléctrica
- Regulador de presión ajustable
- Válvula proporcional manual
- Filtro de línea

CERES - EPCF 02

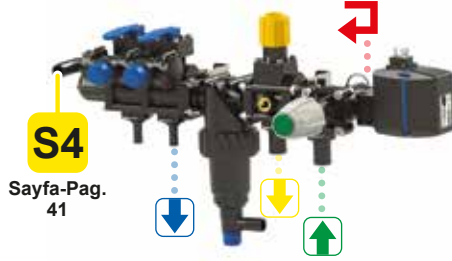

KOD CODE - CÓDIGO	Çıkış Ways - Vias	lt/min	Bar
1030141812	2	180	20

GİRİŞ - IN	ÇIKIŞ - OUT	ÇIKIŞ - OUT	BY-PASS
Sayfa-Pag. 44	Sayfa-Pag. 42	Sayfa-Pag. 43	Sayfa-Pag. 44

CERES - EPCF 03

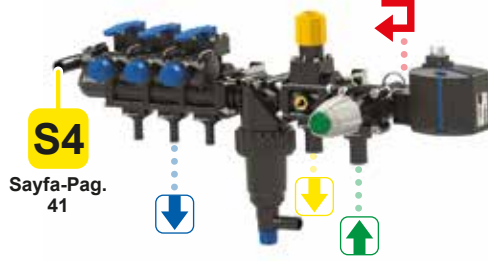

KOD CODE - CÓDIGO	Çıkış Ways - Vias	lt/min	Bar
1030141813	3	180	20

GİRİŞ - IN	ÇIKIŞ - OUT	ÇIKIŞ - OUT	BY-PASS
Sayfa-Pag. 44	Sayfa-Pag. 42	Sayfa-Pag. 43	Sayfa-Pag. 44

CERES - EPCF 04

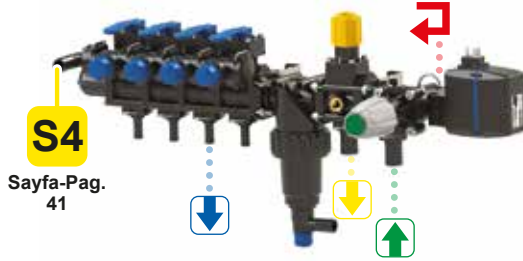

KOD CODE - CÓDIGO	Çıkış Ways - Vias	lt/min	Bar
1030141814	4	180	20

GİRİŞ - IN	ÇIKIŞ - OUT	ÇIKIŞ - OUT	BY-PASS
Sayfa-Pag. 44	Sayfa-Pag. 42	Sayfa-Pag. 43	Sayfa-Pag. 44

CERES - EPCF 05

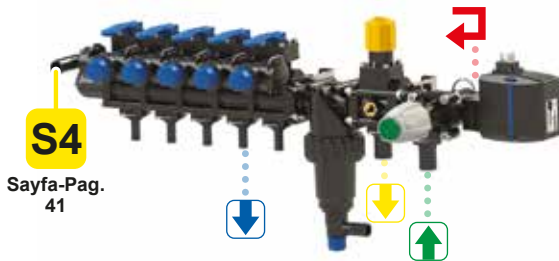

KOD CODE - CÓDIGO	Çıkış Ways - Vias	lt/min	Bar
1030141815	5	180	20

GİRİŞ - IN	ÇIKIŞ - OUT	ÇIKIŞ - OUT	BY-PASS
Sayfa-Pag. 44	Sayfa-Pag. 42	Sayfa-Pag. 43	Sayfa-Pag. 44

CERES - EPCF 06

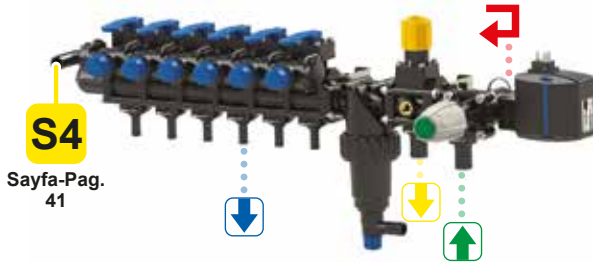

KOD CODE - CÓDIGO	Çıkış Ways - Vias	lt/min	Bar
1030141816	6	180	20

GİRİŞ - IN	ÇIKIŞ - OUT	ÇIKIŞ - OUT	BY-PASS
Sayfa-Pag. 44	Sayfa-Pag. 42	Sayfa-Pag. 43	Sayfa-Pag. 44

CERES - EPCF 07

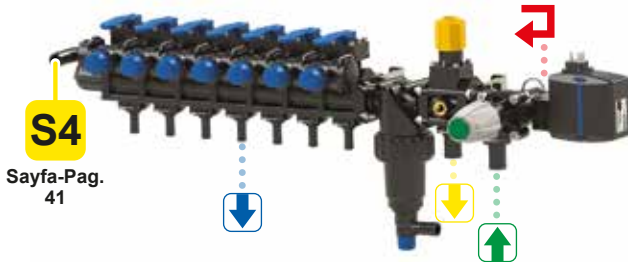

KOD CODE - CÓDIGO	Çıkış Ways - Vias	lt/min	Bar
1030141817	7	180	20

GİRİŞ - IN	ÇIKIŞ - OUT	ÇIKIŞ - OUT	BY-PASS
Sayfa-Pag. 44	Sayfa-Pag. 42	Sayfa-Pag. 43	Sayfa-Pag. 44

CERES EKO SERİSİ-FLANŞLI / CERES ECO SERIES-FLANGED / SERIE CERES ECO-BRIDADA**CERES EKO - F FLANŞLI
KUMANDA ÜNİTELERİ**

- El ile kumanda edilen hat vanaları
- El ile kumanda edilen ana kontrol vanası
- Ayarlanabilir basınç regülatörü

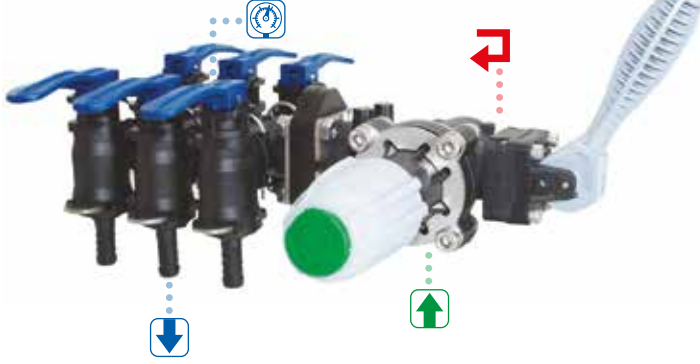
**CERES ECO - F FLANGED
CONTROL UNITS**

- Manual section valves
- Manual main control valve
- Adjustable pressure regulator

**CERES ECO - UNIDADES DE
CONTROL CON BRIDA F**

- Válvulas de sección manuales
- Válvula de control principal manual
- Regulador de presión ajustable

KOD CODE - CÓDIGO	Çıkış Ways - Vías	lt/min	Bar
1030262002	2	180	20
1030262003	3		
1030262004	4		
1030262005	5		
1030262006	6		

GİRİŞ - IN	ÇIKIŞ - OUT	BY-PASS	
Sayfa-Pag. 44	Sayfa-Pag. 42	Sayfa-Pag. 44	Sayfa-Pag. 252-253

**CERES EKO - FF FLANŞLI
KUMANDA ÜNİTELERİ**

- El ile kumanda edilen hat vanaları
- El ile kumanda edilen ana kontrol vanası
- Ayarlanabilir basınç regülatörü
- Hat filtresi (Düz Model)

**CERES ECO - FF FLANGED
CONTROL UNITS**

- Manual section valves
- Manual main control valve
- Adjustable pressure regulator
- Line filter

**CERES ECO - UNIDADES DE
CONTROL CON BRIDA FF**

- Válvulas de sección manuales
- Válvula de control principal manual
- Regulador de presión ajustable
- Filtro de línea

KOD CODE - CÓDIGO	Çıkış Ways - Vías	lt/min	Bar
1030262022	2	180	20
1030262023	3		
1030262024	4		
1030262025	5		
1030262026	6		

GİRİŞ - IN	ÇIKIŞ - OUT	BY-PASS	
Sayfa-Pag. 44	Sayfa-Pag. 42	Sayfa-Pag. 44	Sayfa-Pag. 252-253

**CERES EKO - FFT FLANŞLI
KUMANDA ÜNİTELERİ**

- El ile kumanda edilen hat vanaları
- El ile kumanda edilen ana kontrol vanası
- Ayarlanabilir basınç regülatörü
- Hat filtresi (Tahliye Vanalı Model)

**CERES ECO - FFT FLANGED
CONTROL UNITS**

- Manual section valves
- Manual main control valve
- Adjustable pressure regulator
- Line filter (Self-cleaning)

**CERES ECO - UNIDADES DE
CONTROL CON BRIDA FFT**

- Válvulas de sección manuales
- Válvula de control principal manual
- Regulador de presión ajustable
- Filtro de línea (Autolimpiantes)

KOD CODE - CÓDIGO	Çıkış Ways - Vías	lt/min	Bar
1030262012	2	180	20
1030262013	3		
1030262014	4		
1030262015	5		
1030262016	6		

GİRİŞ - IN	ÇIKIŞ - OUT	BY-PASS	
Sayfa-Pag. 44	Sayfa-Pag. 42	Sayfa-Pag. 44	Sayfa-Pag. 252-253

CERES EKO SERİSİ-SEGMANLI/CERES ECO SERIES-WITH FORK CONNECTION/SERIE CERES ECO-CON CONEXIÓN DE HORQUILLA

CERES EKO - S SEGMANLI
KUMANDA ÜNİTELERİ

- El ile kumanda edilen hat vanaları
- El ile kumanda edilen ana kontrol vanası
- Ayarlanabilir basınç regülatörü

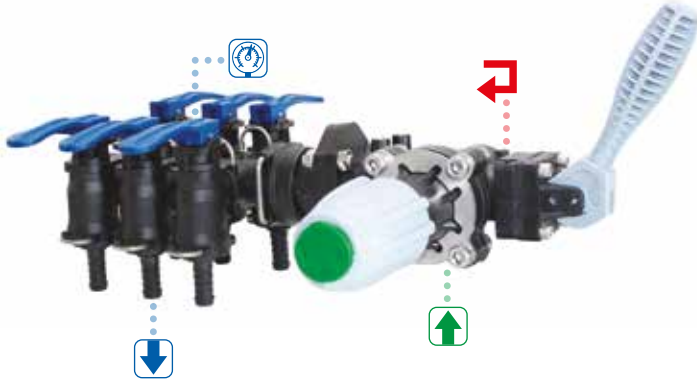
CERES ECO - S CONTROL UNITS
WITH FORK CONNECTION

- Manual section valves
- Manual main control valve
- Adjustable pressure regulator

CERES ECO - UNIDADES DE CONTROL
CON CONEXIÓN DE HORQUILLA S

- Válvulas de sección manuales
- Válvula de control principal manual
- Regulador de presión ajustable

KOD CODE - CÓDIGO	Çıkış Ways - Vias	lt/min	Bar
1030272002	2	180	20
1030272003	3		
1030272004	4		
1030272005	5		
1030272006	6		

GİRİŞ - IN Çıkış - OUT	BY-PASS	
Sayfa-Pag. 44	Sayfa-Pag. 42	Sayfa-Pag. 44
		Sayfa-Pag. 252-253

CERES EKO - SF SEGMANLI
KUMANDA ÜNİTELERİ

- El ile kumanda edilen hat vanaları
- El ile kumanda edilen ana kontrol vanası
- Ayarlanabilir basınç regülatörü
- Hat filtresi (Düz Model)

CERES ECO - SF CONTROL UNITS
WITH FORK CONNECTION

- Manual section valves
- Manual main control valve
- Adjustable pressure regulator
- Line filter

CERES ECO - UNIDADES DE CONTROL
CON CONEXIÓN DE HORQUILLA SF

- Válvulas de sección manuales
- Válvula de control principal manual
- Regulador de presión ajustable
- Filtro de línea

KOD CODE - CÓDIGO	Çıkış Ways - Vias	lt/min	Bar
1030272022	2	180	20
1030272023	3		
1030272024	4		
1030272025	5		
1030272026	6		

GİRİŞ - IN Çıkış - OUT	BY-PASS	
Sayfa-Pag. 44	Sayfa-Pag. 42	Sayfa-Pag. 44
		Sayfa-Pag. 252-253

CERES EKO - SFT SEGMANLI
KUMANDA ÜNİTELERİ

- El ile kumanda edilen hat vanaları
- El ile kumanda edilen ana kontrol vanası
- Ayarlanabilir basınç regülatörü
- Hat filtresi (Tahliye Vanalı Model)

CERES ECO - SFT CONTROL UNITS
WITH FORK CONNECTION

- Manual section valves
- Manual main control valve
- Adjustable pressure regulator
- Line filter (Self-cleaning)

CERES ECO - UNIDADES DE CONTROL
CON CONEXIÓN DE HORQUILLA SFT

- Válvulas de sección manuales
- Válvula de control principal manual
- Regulador de presión ajustable
- Filtro de línea (Autolimpiantes)

KOD CODE - CÓDIGO	Çıkış Ways - Vias	lt/min	Bar
1030272012	2	180	20
1030272013	3		
1030272014	4		
1030272015	5		
1030272016	6		

GİRİŞ - IN Çıkış - OUT	BY-PASS	
Sayfa-Pag. 44	Sayfa-Pag. 42	Sayfa-Pag. 44
		Sayfa-Pag. 252-253

CERES EKO SERİSİ / CERES ECO SERIES / SERIE CERES ECO

FLANŞLI MANİFOLD

FLANGED MANIFOLD

COLECTOR CON BRIDA



ADAPT.
Sayfa-Pag.
42

KOD CODE - CÓDIGO	Çıkış Ways - Vias
10141002	2
10141003	3
10141004	4
10141005	5
10141006	6

SEGMANLI MANİFOLD

MANIFOLD WITH FORK CONNECTION

COLECTOR CON CONEXIÓN DE HORQUILLA



KOD CODE - CÓDIGO	Çıkış Ways - Vias
10142002	2
10142003	3
10142004	4
10142005	5
10142006	6

PASOLU MANİFOLD

THREADED MANIFOLD

COLECTOR CON RACOR DE MANGUERA



KOD CODE - CÓDIGO	Çıkış Ways - Vias
10143002	2
10143003	3
10143004	4
10143005	5
10143006	6

MİNİ AÇ/KAPA VANA

MINI ON/OFF VALVE

MINI VÁLVULAS DE ON/OFF



KOD
CODE - CÓDIGO

10141120M

Diğer renk seçenekleri için lütfen irtibata geçiniz / Other colors upon request / A pedido están disponibles otros colores

ANA KONTROL VANASI
(AYARLANABİLİR BASINÇ
REGÜLATÖRÜ VE EL İLE
KUMANDALI AÇ / KAPA)

MANUAL MAIN CONTROL
VALVE WITH MANUAL
ADJUSTABLE PRESSURE
RELIEF VALVE

GRUPOS DE MANDO GENERAL
MANUAL CON VÁLVULA DE
ALIVIO DE PRESIÓN
AJUSTABLE MANUALMENTE



KOD CODE - CÓDIGO	Bar	lt/min
1030111800	20	180

GİRİŞ - IN	ADAPT.	BY-PASS
Sayfa-Pag. 44	Sayfa-Pag. 42	Sayfa-Pag. 44

ANA KONTROL VANASI + EL İLE
KUMANDALI ORANSAL VANA
(AYARLANABİLİR BASINÇ
REGÜLATÖRÜ VE EL İLE
KUMANDALI AÇ / KAPA)

MANUAL MAIN CONTROL
VALVE WITH MANUAL
PROPORTIONAL VALVE AND
MANUAL ADJUSTABLE
PRESSURE RELIEF VALVE

GRUPOS DE MANDO GENERAL
MANUAL CON VÁLVULA
PROPORCIONAL MANUAL Y
VÁLVULA DE ALIVIO DE PRESIÓN
AJUSTABLE MANUALMENTE

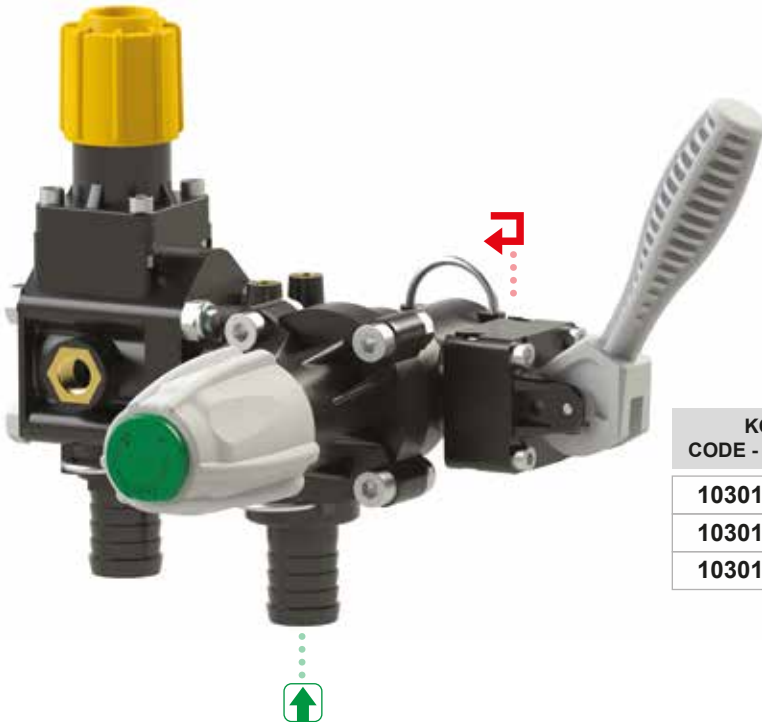

KOD CODE - CÓDIGO	Bar	lt/min	Ø		
				Bar	lt/min
1030130600	40	60	13	20	180
1030131000		100	19		
1030131500		150	25		

GİRİŞ - IN	BY-PASS
Sayfa-Pag. 44	Sayfa-Pag. 44

ANA KONTROL VANASI
(AYARLANABİLİR BASINÇ
REGÜLATÖRÜ VE ELEKTRİK
KUMANDALI AÇ / KAPA)

**ELECTRIC MAIN CONTROL
VALVE WITH MANUAL
ADJUSTABLE PRESSURE
RELIEF VALVE**

**GRUPOS DE MANDO GENERAL
ELÉCTRICOS CON VÁLVULA DE
ALIVIO DE PRESIÓN AJUSTABLE
MANUALMENTE**

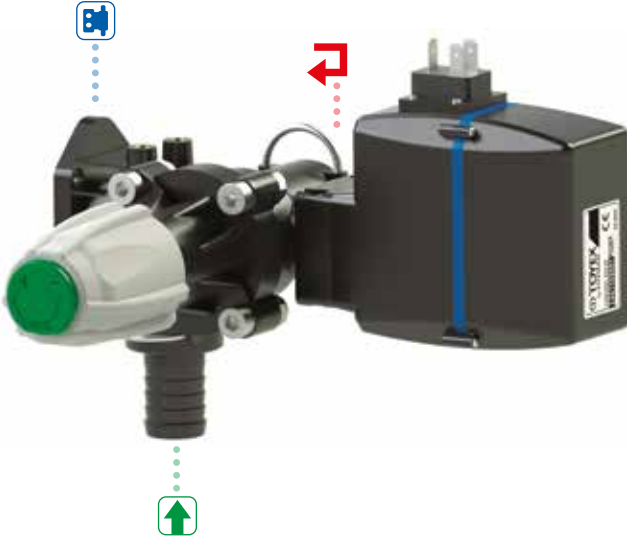

KOD CODE - CÓDIGO	Bar	lt/min	⚡	Sec
1030121800	20	180	12V DC	0.5 sec

GİRİŞ - IN ↑ Sayfa-Pag. 44	ADAPT. ⚡ Sayfa-Pag. 42	BY-PASS ↺ Sayfa-Pag. 44
-------------------------------------	---------------------------------	----------------------------------

**ANA KONTROL VANASI + EL
İLE KUMANDALI ORANSAL VANA**
(AYARLANABİLİR BASINÇ
REGÜLATÖRÜ VE ELEKTRİK
KUMANDALI AÇ / KAPA)

**ELECTRIC MAIN CONTROL
VALVE WITH MANUAL
PROPORTIONAL VALVE AND
MANUAL ADJUSTABLE
PRESSURE RELIEF VALVE**

**GRUPOS DE MANDO GENERAL
ELÉCTRICOS CON VÁLVULA
PROPORCIONAL MANUAL Y
VÁLVULA DE ALIVIO DE PRESIÓN
AJUSTABLE MANUALMENTE**

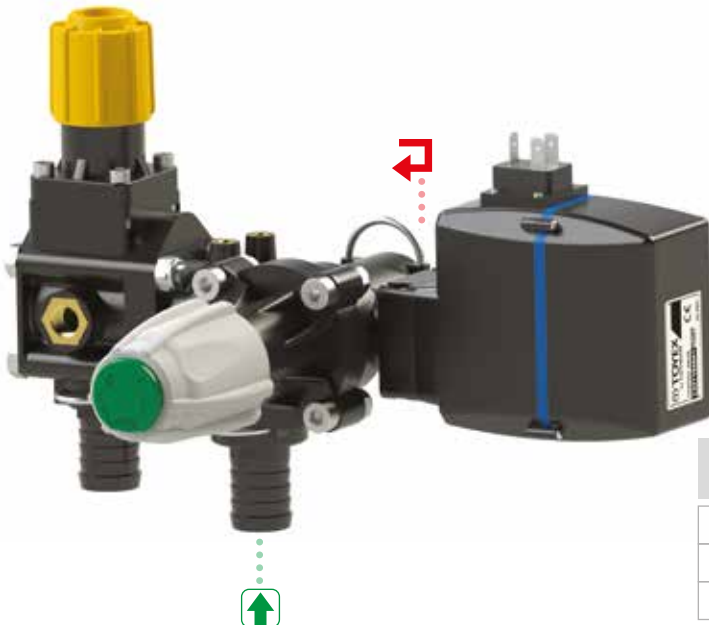

KOD CODE - CÓDIGO	Bar	lt/min	Ø	Bar	lt/min	⚡	Sec
1030140600	40	60	13	20	180	12V DC	0.5 sec
1030141000		100	19				
1030141500		150	25				

GİRİŞ - IN ↑ Sayfa-Pag. 44	BY-PASS ↺ Sayfa-Pag. 44
-------------------------------------	----------------------------------

ANA KONTROL VANASI + ELEKTRİK İLE KUMANDALI ORANSAL VANA (AYARLANABİLİR BASINÇ REGÜLATÖRÜ VE ELEKTRİK KUMANDALI AÇ / KAPA)

ELECTRIC MAIN CONTROL VALVE WITH ELECTRIC PROPORTIONAL VALVE AND MANUAL ADJUSTABLE PRESSURE RELIEF VALVE

GRUPOS DE MANDO GENERAL ELÉCTRICOS CON VÁLVULA PROPORCIONAL MANUAL Y VÁLVULA DE ALIVIO DE PRESIÓN AJUSTABLE MANUALMENTE



GİRİŞ - IN
↑
Sayfa-Pag.
44

BY-PASS
↶
Sayfa-Pag.
44

KOD CODE - CÓDIGO	Bar	⚡	Sec	lt/min	Ø	Bar	lt/min	⚡	Sec
1030150600	40	12V DC	14 sec	60	13	20	180	12V DC	0.5 sec
1030151000				100	19				
1030151500				150	25				

ANA KONTROL VANASI + ELEKTRİK İLE KUMANDALI ORANSAL VANA (AYARLANABİLİR BASINÇ REGÜLATÖRÜ VE ELEKTRİK KUMANDALI AÇ / KAPA)

ELECTRIC MAIN CONTROL VALVE WITH ELECTRIC PROPORTIONAL VALVE AND MANUAL ADJUSTABLE PRESSURE RELIEF VALVE

GRUPOS DE MANDO GENERAL ELÉCTRICOS CON VÁLVULA PROPORCIONAL MANUAL Y VÁLVULA DE ALIVIO DE PRESIÓN AJUSTABLE MANUALMENTE



GİRİŞ - IN
↑
Sayfa-Pag.
44

BY-PASS
↶
Sayfa-Pag.
44

KOD CODE - CÓDIGO	Bar	⚡	Sec	lt/min	Ø	Bar	lt/min	⚡	Sec
1030230600	40	12V DC	7 sec	60	13	20	180	12V DC	0.5 sec
1030231000				100	19				
1030231500				150	25				

ORANSAL VANA
EL İLE KUMANDALIMANUAL PROPORTIONAL
CONTROL VALVEVÁLVULA PROPORCIONAL
MANUAL

KOD CODE - CÓDIGO	Bar	lt/min	Ø
101100306	40	60	13
101100310		100	19
101100315		150	25

ORANSAL VANA
ELEKTRİKLİELECTRIC PROPORTIONAL
CONTROL VALVEVÁLVULA PROPORCIONAL
ELÉCTRICA

KOD CODE - CÓDIGO	Bar	⚡	Sec	lt/min	Ø
102100306	40	12V DC	14 sec	60	13
102100310				100	19
102100315				150	25

ORANSAL VANA
ELEKTRİKLİELECTRIC PROPORTIONAL
CONTROL VALVEVÁLVULA PROPORCIONAL
ELÉCTRICA

KOD CODE - CÓDIGO	Bar	⚡	Sec	lt/min	Ø
102100406	40	12V DC	7 sec	60	13
102100410				100	19
102100415				150	25

ELEKTRİKLİ ORANSAL KONTROLLÜ,
ELEKTRİK İLE KUMANDA EDİLEN
VE GERİ DÖNÜŞ KALİBRASYONLU
HAT VANA GRUBU

ELECTRIC SECTION VALVES
WITH BY-PASS CALIBRATION
AND WITH ELECTRIC
PROPORTIONAL VALVE

VÁLVULAS DE SECCIÓN
ELÉCTRICAS CON CALIBRACIÓN
POR BY-PASS Y CON VÁLVULA
PROPORCIONAL ELÉCTRICA



S4
Sayfa-Pag.
41

KOD CODE - CÓDIGO	Vanalar Valves Valvulas	Bar	⚡
1030162002	2	20	12V DC
1030162003	3		
1030162004	4		
1030162005	5		
1030162006	6		
1030162007	7		

ADAPT.	ÇIKIŞ - OUT	ÇIKIŞ - OUT	BY-PASS	⚡
⚡	↓	↓	↺	⚡
Sayfa-Pag. 42	Sayfa-Pag. 42	Sayfa-Pag. 43	Sayfa-Pag. 44	Sayfa-Pag. 252-253

EL İLE ORANSAL KONTROLLÜ,
ELEKTRİK İLE KUMANDA EDİLEN
VE GERİ DÖNÜŞ KALİBRASYONLU
HAT VANA GRUBU

ELECTRIC SECTION VALVES
WITH BY-PASS CALIBRATION
AND WITH MANUAL
PROPORTIONAL VALVE

VÁLVULAS DE SECCIÓN
ELÉCTRICAS CON CALIBRACIÓN
POR BY-PASS Y CON VÁLVULA
PROPORCIONAL MANUAL



S4
Sayfa-Pag.
41

KOD CODE - CÓDIGO	Vanalar Valves Valvulas	Bar	⚡
1030172002	2	20	12V DC
1030172003	3		
1030172004	4		
1030172005	5		
1030172006	6		
1030172007	7		

ADAPT.	ÇIKIŞ - OUT	ÇIKIŞ - OUT	BY-PASS	⚡
⚡	↓	↓	↺	⚡
Sayfa-Pag. 42	Sayfa-Pag. 42	Sayfa-Pag. 43	Sayfa-Pag. 44	Sayfa-Pag. 252-253

EL İLE ORANSAL KONTROLLÜ,
EL İLE KUMANDA EDİLEN VE
GERİ DÖNÜŞ KALİBRASYONLU
HAT VANA GRUBU

MANUAL SECTION VALVES
WITH BY-PASS CALIBRATION
AND WITH MANUAL
PROPORTIONAL VALVE

VÁLVULAS DE SECCIÓN
MANUALES CON CALIBRACIÓN
POR BY-PASS Y Y CON VÁLVULA
PROPORCIONAL MANUAL



S4
Sayfa-Pag.
41

KOD CODE - CÓDIGO	Vanalar Valves Valvulas	Bar	⚡
1030182002	2	20	12V DC
1030182003	3		
1030182004	4		
1030182005	5		
1030182006	6		
1030182007	7		

ADAPT.	ÇIKIŞ - OUT	ÇIKIŞ - OUT	BY-PASS	⚡
⚡	↓	↓	↺	⚡
Sayfa-Pag. 42	Sayfa-Pag. 42	Sayfa-Pag. 43	Sayfa-Pag. 44	Sayfa-Pag. 252-253

ELEKTRİK İLE KUMANDA
EDİLEN VE GERİ DÖNÜŞ
KALİBRASYONLU HAT VANA GRUBUELECTRIC SECTION
VALVES WITH BY-PASS
CALIBRATIONVÁLVULAS DE SECCIÓN
ELÉCTRICAS CON
CALIBRACIÓN POR BY-PASSSayfa-Pag.
41

KOD CODE - CÓDIGO	Vanalar Valves Valvulas	Bar	⚡
1030192002	2	20	12V DC
1030192003	3		
1030192004	4		
1030192005	5		
1030192006	6		
1030192007	7		

ADAPT.

Sayfa-Pag.
42

ÇIKIŞ - OUT

Sayfa-Pag.
42Sayfa-Pag.
252-253ELEKTRİK İLE KUMANDA
EDİLEN HAT VANA GRUBU

ELECTRIC SECTION VALVES

VÁLVULAS DE SECCIÓN
ELÉCTRICAS

KOD CODE - CÓDIGO	Vanalar Valves Valvulas	Bar	⚡
1030202002	2	20	12V DC
1030202003	3		
1030202004	4		
1030202005	5		
1030202006	6		
1030202007	7		

ADAPT.

Sayfa-Pag.
42

ÇIKIŞ - OUT

Sayfa-Pag.
42Sayfa-Pag.
252-253

EL İLE KUMANDA
EDİLEN HAT VANA GRUBU

MANUAL SECTION
VALVES

VÁLVULAS DE SECCIÓN
MANUALES

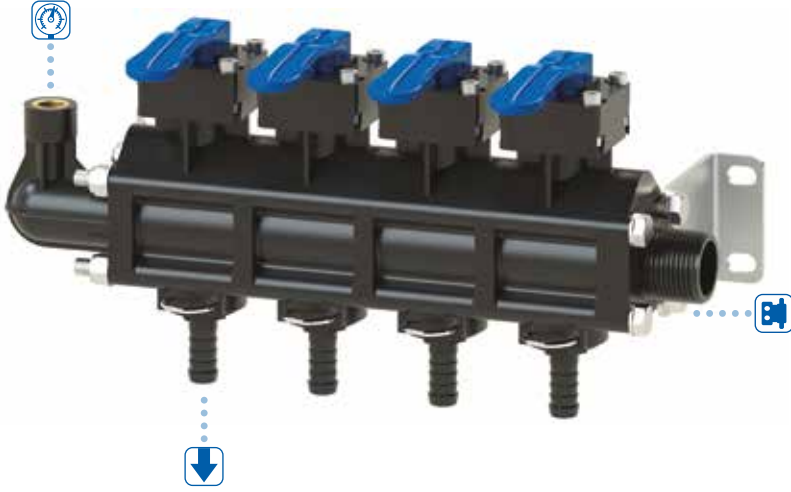

KOD CODE - CÓDIGO	Vanalar Valves Valvulas	Bar	⚡
1030212002	2	20	12V DC
1030212003	3		
1030212004	4		
1030212005	5		
1030212006	6		
1030212007	7		

ADAPT. ÇIKIŞ - OUT



Sayfa-Pag.
42



Sayfa-Pag.
42



Sayfa-Pag.
252-253

EL İLE KUMANDA
EDİLEN VE GERİ DÖNÜŞ
KALİBRASYONLU HAT VANA GRUBU

MANUAL SECTION
VALVES WITH BY-PASS
CALIBRATION

VÁLVULAS DE SECCIÓN
MANUALES CON CALIBRACIÓN
POR BY-PASS



S4
Sayfa-Pag.
41

KOD CODE - CÓDIGO	Vanalar Valves Valvulas	Bar	⚡
1030222002	2	20	12V DC
1030222003	3		
1030222004	4		
1030222005	5		
1030222006	6		
1030222007	7		

ADAPT. ÇIKIŞ - OUT



Sayfa-Pag.
42



Sayfa-Pag.
42



Sayfa-Pag.
252-253

ELEKTRİKLİ
AÇ/KAPA VANALARON/OFF ELECTRIC
SECTION VALVESVÁLVULAS DE SECCIÓN
ELÉCTRICAS ON/OFF

3 Yönlü / 3 Way / 3 Vias



ÇIKIŞ - OUT ↓ Sayfa-Pag. 42

KOD CODE - CÓDIGO	lt/min	Bar	⚡
10210010M	15÷45	20	12V DC



ÇIKIŞ - OUT ↓ Sayfa-Pag. 42

KOD CODE - CÓDIGO	lt/min	Bar	⚡
10210015M	15÷45	20	12V DC

*Debi değerleri 0.5 bar basınçta, farklı bağlantı eleman çaplarına göre farklılık göstermektedir
Flow rate depends on different fitting diameters at 0.5 bars / El caudal depende de diferentes diámetros de conexión a 0,5 bares

EL İLE KUMANDALI
AÇ/KAPA VANALARON/OFF MANUAL
SECTION VALVESVÁLVULAS DE SECCIÓN
MANUALES ON/OFF

3 Yönlü / 3 Way / 3 Vias



ÇIKIŞ - OUT ↓ Sayfa-Pag. 42

KOD CODE - CÓDIGO	lt/min	Bar
10110010K	15÷45	20



ÇIKIŞ - OUT ↓ Sayfa-Pag. 42

KOD CODE - CÓDIGO	lt/min	Bar
10110015K	15÷45	20

* Debi değerleri 0.5 bar basınçta, farklı bağlantı eleman çaplarına göre farklılık göstermektedir / Diğer renk seçenekleri için lütfen irtibata geçiniz

* Flow rate depends on different fitting diameters at 0.5 bars / Other colors upon request

* El caudal depende de diferentes diámetros de conexión a 0,5 bares / A pedido están disponibles otros colores

ELEKTRİKLİ
AÇ/KAPA VANALARON/OFF ELECTRIC
SECTION VALVESVÁLVULAS DE SECCIÓN
ELÉCTRICAS ON/OFF

3 Yönlü / 3 Way / 3 Vias



KOD CODE - CÓDIGO	lt/min	Bar	⚡
10210011M	15÷45	40	12V DC



KOD CODE - CÓDIGO	lt/min	Bar	⚡
10210016M	15÷45	40	12V DC

EL İLE KUMANDALI
AÇ/KAPA VANALARON/OFF MANUAL
SECTION VALVESVÁLVULAS DE SECCIÓN
MANUALES ON/OFF

3 Yönlü / 3 Way / 3 Vias



KOD CODE - CÓDIGO	lt/min	Bar
10110021K	15÷45	40



KOD CODE - CÓDIGO	lt/min	Bar
10110026K	15÷45	40

KALİBRASYON VANASI

CALIBRATION VALVE

VÁLVULA DE CALIBRACION

KOD
CODE - CÓDIGO

10110018

MONTAJ KİTİ

ASSEMBLY KIT

KIT DE MONTAJE



KOD CODE - CÓDIGO	Vanalar Valves Valvulas	L (mm)	Tip Type Tipo	Oring - O-Ring Junta Tórica
10101441	1	80	INOX	OR2623934V
10101442	2	150		
10101443	3	205		
10101444	4	265		
10101445	5	320		
10101446	6	380		
10101447	7	435		
10101448	8	490		
10101449	9	547		
10101450	10	605		

BAĞLANTI ELEMANLARI

FITTINGS

RACORES

Segman
Fork / Horquilla

KOD CODE - CÓDIGO	S
01029904	S4

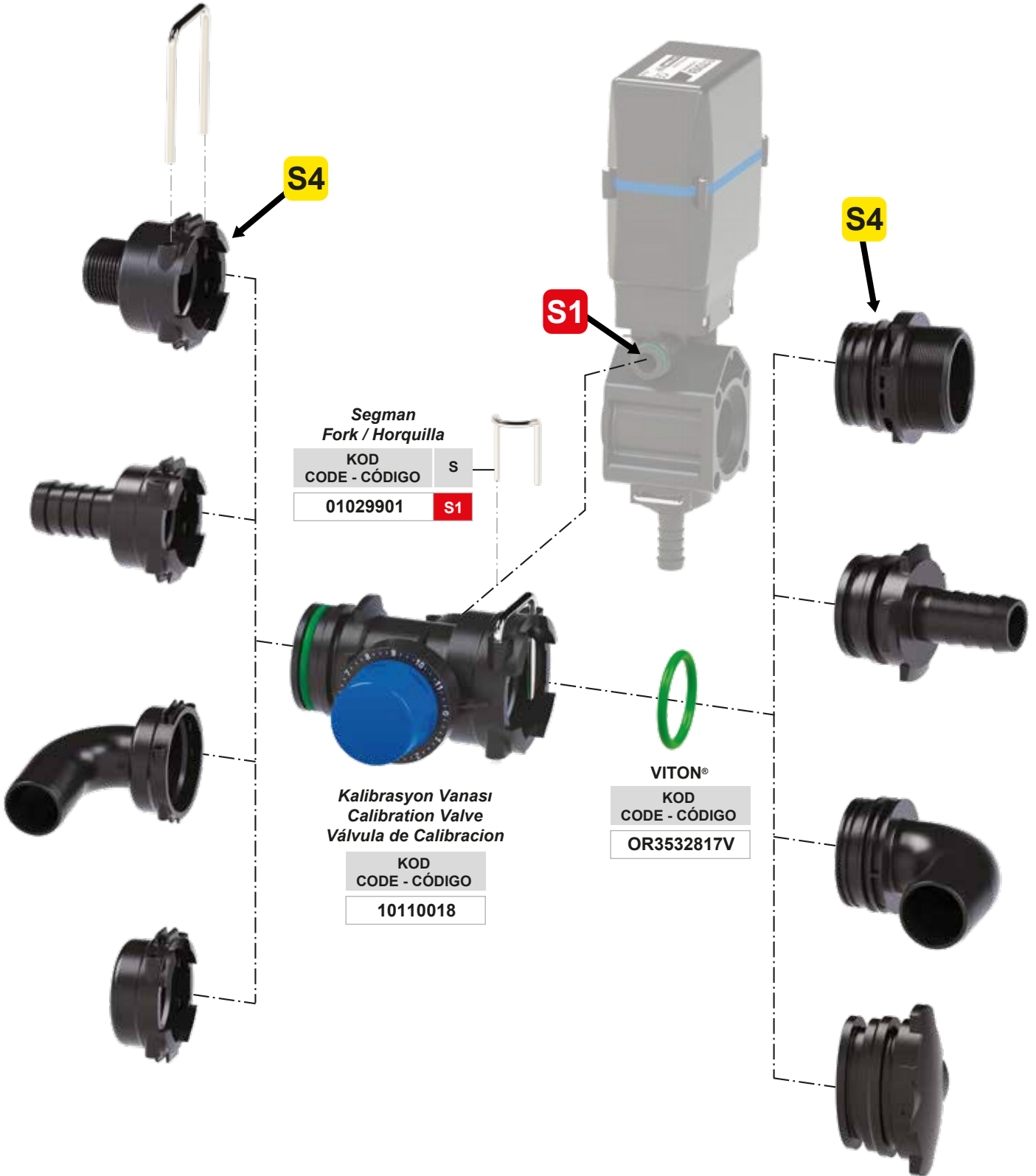

Segman
Fork / Horquilla

KOD CODE - CÓDIGO	S
01029901	S1

Kalibrasyon Vanası
Calibration Valve
Válvula de Calibracion

KOD CODE - CÓDIGO
10110018

VITON®
KOD
CODE - CÓDIGO
OR3532817V

Erkek Adaptör / Male Adapter
Brida Rosca Macho

KOD CODE - CÓDIGO	F
10101111	G ½"
10101112	G ¾"
10101113	G 1"
Pirinç - Brass - Latón	
10101111P	G ½"
10101112P	G ¾"
10101113P	G 1"

Kapalı Adaptör
Closed Adapter / Brida Ciega

KOD CODE - CÓDIGO	
10101131	
Pirinç - Brass - Latón	
10101131P	

Segmanlı Adaptör Erkek
Adapter Male With Fork Coupling
Adaptador Macho Con
Acoplamiento de Horquilla

KOD CODE - CÓDIGO	S
10101141S3	S3
10101141S5	S5

Segmanlı Adaptör Dişi
Adapter Female With
Fork Coupling
Adaptador Hembra Con
Acoplamiento de Horquilla

KOD CODE - CÓDIGO	S
10101142S5	S5

Manometre Bağlantı Adaptörü
Pressure Gauge Adapter
Brida Portamanómetro

KOD CODE - CÓDIGO	F
10101151	G ¼" - 90°
10101153	G ¼" - 15°
Pirinç - Brass - Latón	
10101152P	G ¼"

F ADAPTÖRLER / ADAPTERS / ADAPTADORES

M

Erkek Adaptör / Male Adapter
Brida Rosca Macho

KOD CODE - CÓDIGO	F
10101211	G ½"
10101212	G ¾"
10101213	G 1"
Pirinç - Brass - Latón	
10101211P	G ½"
10101212P	G ¾"
10101213P	G 1"

Kapalı Adaptör
Closed Adapter / Brida Ciega

KOD CODE - CÓDIGO	
10101231	
Pirinç - Brass - Latón	
10101231P	

Segmanlı Adaptör Erkek
Adapter Male With Fork Coupling
Adaptador Macho Con
Acoplamiento de Horquilla

KOD CODE - CÓDIGO	S
10101241S3	S3
10101241S5	S5

Segmanlı Adaptör Dişi
Adapter Female With
Fork Coupling
Adaptador Hembra Con
Acoplamiento de Horquilla

KOD CODE - CÓDIGO	S
10101242S5	S5

Oring / O-Ring
Junta Tórica
KOD
CODE - CÓDIGO
OR2623934VOring / O-Ring
Junta Tórica
KOD
CODE - CÓDIGO
OR262222V

Rekor / Hose Fitting / Racor

KOD CODE - CÓDIGO	Ø
10101311	Ø 10
10101312	Ø 13
10101313	Ø 16
10101314	Ø 19
10101315	Ø 25

Dişi Nipel / Nipple F / Unión H

KOD CODE - CÓDIGO	F
10101342	G ¾"
10101343	G 1"

Erkek Nipel / Nipple M / Unión M

KOD CODE - CÓDIGO	F
10101331	G ½"
10101332	G ¾"
10101333	G 1"
Pirinç - Brass - Latón	
10101331P	G ½"

Dirsek
90° Hose Fitting
Racor Portamangueras Curvo 90°

KOD CODE - CÓDIGO	Ø
10101321	Ø 10
10101322	Ø 13
10101325	Ø 25

BAĞLANTI ELEMANLARI

FITTINGS

RACORES

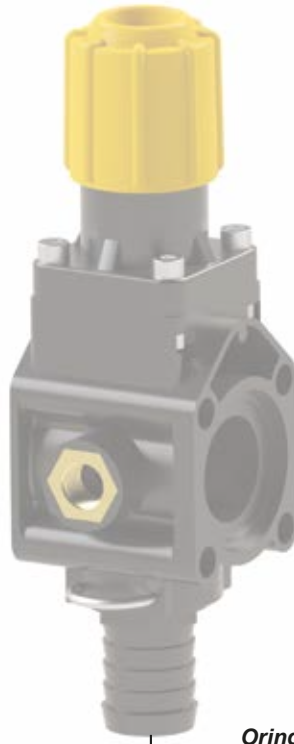

*Oring / O-Ring
Junta Tórica*

KOD
CODE - CÓDIGO

OR262222V



*Rekor / Hose Fitting
Racor*

KOD CODE - CÓDIGO	Ø	D (mm)
1010131210	Ø 13	10
1010131414	Ø 19	14
1010131416	Ø 19	16
1010131516	Ø 25	16



*Dişi Nipel / Nipple F
Unión H*

KOD CODE - CÓDIGO	F
1010134214	G ¾"



*Erkek Nipel / Nipple M
Unión M*

KOD CODE - CÓDIGO	F
1010133310	G 1"
1010133214	G ¾"
1010133316	G 1"

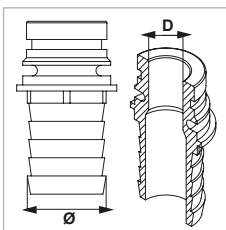

BAĞLANTI ELEMANLARI

FITTINGS

RACORES

Erkek Adaptör
Male Adapter
Brida Rosca Macho

KOD CODE - CÓDIGO	F
10101112	G ¾"
10101113	G 1"

**Segmanlı Adaptör Erkek**
Adapter Male With Fork Coupling
Adaptador Macho Con
Acoplamiento de Horquilla

KOD CODE - CÓDIGO	S
10101141S5	S5

**Segmanlı Adaptör Dişi**
Adapter Female With
Fork Coupling
Adaptador Hembra Con
Acoplamiento de Horquilla

KOD CODE - CÓDIGO	S
10101142S5	S5

**Oring / O-Ring**
Junta Tórica

KOD CODE - CÓDIGO
OR2623934V

**Oring / O-Ring**
Junta Tórica

KOD CODE - CÓDIGO
OR2622507V

**Oring / O-Ring**
Junta Tórica

KOD CODE - CÓDIGO
OR3532817V

By-Pass Rekor
Hose Fitting / Racor

KOD CODE - CÓDIGO	Ø	Max Pompa Pump / Bomba lt/min
1010139112	Ø 25	70
1010139216	Ø 30	120
1010139316	Ø 32	120
1010139419	Ø 35	180

**Dirsek**
90° Hose Fitting
Racor Portamangueras Curvo 90°

KOD CODE - CÓDIGO	Ø
1010136120	Ø 25

**Rekor**
Hose Fitting
Racor

KOD CODE - CÓDIGO	Ø
1010135120	Ø 19
1010135220	Ø 25
1010135320	Ø 30
1010135420	Ø 32

**Erkek Nipel**
Nipple M
Unión M

KOD CODE - CÓDIGO	Ø
1010137220	G ¾"
1010137320	G 1"
1010137420	G 1 ¼"

SEGMAN BAĞLANTILI HAT FİLTRESİ S5 ERKEK / DIŞI (DÜZ MODEL)

- S5 Erkek / Dişi segman bağlantılı
- Max basınç: 20 bar
- Filtreleme kapasitesi 200+280 lt/dak
- Paslanmaz Inox süzgeç
- Çift taraflı bağlantı imkanı
- EPDM Oring (VITON® isteğe bağlı)



LINE FILTERS S5 MALE / FEMALE FORK COUPLING

- S5 Male / Female fork coupling
- Max. operating pressure 20 bar
- Filtering capacity 200+280 l/min
- Stainless steel cartridge
- Can be fixed in both sides
- EPDM gaskets (VITON® optional)

KOD CODE - CÓDIGO	F	A (mm)	Mesh	Süzgeç Cartridge Cartucho
060522303	S5	144	30 Mesh	INOX
060522305			50 Mesh	
060522308			80 Mesh	
0605223010			100 Mesh	

YEDEK PARÇA / SPARE PARTS / REPUESTOS

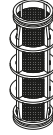

KOD CODE - CÓDIGO	Mesh	Süzgeç Cartridge Cartucho
06020630	30 Mesh	INOX
06020650	50 Mesh	
06020680	80 Mesh	
060206100	100 Mesh	

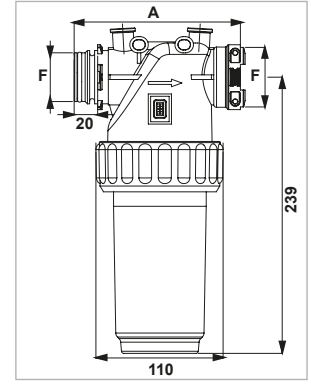

SEGMAN BAĞLANTILI HAT FİLTRESİ S5 ERKEK / DIŞI (TAHLİYE VANALI MODEL)

- S5 Erkek / Dişi segman bağlantılı
- Max basınç: 20 bar
- Filtreleme kapasitesi 200+280 lt/dak
- Paslanmaz Inox süzgeç
- Çift taraflı bağlantı imkanı
- EPDM Oring (VITON® isteğe bağlı)



LINE FILTERS S5 MALE / FEMALE FORK COUPLING (SELF - CLEANING)

- S5 Male / Female fork coupling
- Max. operating pressure 20 bar
- Filtering capacity 200+280 l/min
- Stainless steel cartridge
- Can be fixed in both sides
- EPDM gaskets (VITON® optional)

KOD CODE - CÓDIGO	F	A (mm)	Mesh	Süzgeç Cartridge Cartucho
060523303M	S5	144	30 Mesh	INOX
060523305M			50 Mesh	
060523308M			80 Mesh	
0605233010M			100 Mesh	

YEDEK PARÇA / SPARE PARTS / REPUESTOS

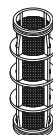

KOD CODE - CÓDIGO	Mesh	Süzgeç Cartridge Cartucho
06020630	30 Mesh	INOX
06020650	50 Mesh	
06020680	80 Mesh	
060206100	100 Mesh	

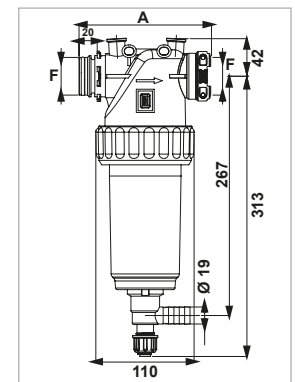

FLANŞ BAĞLANTILI HAT FİLTRESİ 160 LT (DÜZ MODEL)

- Flanş bağlantılı
- Max basınç: 20 bar
- Filtreleme kapasitesi 150+160 lt/dak
- Paslanmaz Inox süzgeç
- Çift taraflı bağlantı imkanı
- EPDM Oring (VITON® isteğe bağlı)



FLANGE CONNECTED LINE FILTER 160 LT

- Flange connected
- Max. operating pressure 20 bar
- Filtering capacity 150+160 l/min
- Stainless steel cartridge
- Can be fixed in both sides
- EPDM gaskets (VITON® optional)

FILTRO DE LÍNEA CON BRIDA CONECTADA 160 LT

- Con brida conectada
- Presión max: 20 bar
- Capacidad filtrante 150+160 l/min
- Cartucho de acero inox
- Puntos de fijación en ambos lados
- Juntas en EPDM (opcional, en VITON®)

KOD CODE - CÓDIGO	A (mm)	Mesh	Süzgeç Cartridge Cartucho
060522803	108	30 Mesh	INOX
060522805		50 Mesh	
060522808		80 Mesh	
0605228010		100 Mesh	

YEDEK PARÇA / SPARE PARTS / REPUESTOS

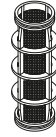

KOD CODE - CÓDIGO	Mesh	Süzgeç Cartridge Cartucho
06020530	30 Mesh	INOX
06020550	50 Mesh	
06020580	80 Mesh	
060205100	100 Mesh	

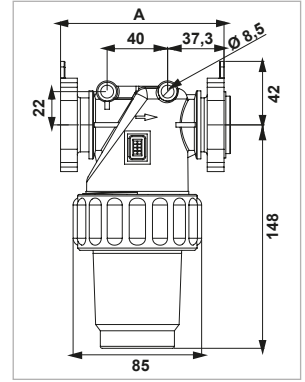

FLANŞ BAĞLANTILI HAT FİLTRESİ 160 LT (TAHLİYE VANALI MODEL)

- Flanş bağlantılı
- Max basınç: 20 bar
- Filtreleme kapasitesi 150+160 lt/dak
- Paslanmaz Inox süzgeç
- Çift taraflı bağlantı imkanı
- EPDM Oring (VITON® isteğe bağlı)



FLANGE CONNECTED LINE FILTER 160 LT (SELF - CLEANING)

- Flange connected
- Max. operating pressure 20 bar
- Filtering capacity 150+160 l/min
- Stainless steel cartridge
- Can be fixed in both sides
- EPDM gaskets (VITON® optional)

FILTRO DE LÍNEA CON BRIDA CONECTADA 160 LT (AUTOLIMPIANTES)

- Con brida conectada
- Presión max: 20 bar
- Capacidad filtrante 150+160 l/min
- Cartucho de acero inox
- Puntos de fijación en ambos lados
- Juntas en EPDM (opcional, en VITON®)

KOD CODE - CÓDIGO	A (mm)	Mesh	Süzgeç Cartridge Cartucho
060523803M	108	30 Mesh	INOX
060523805M		50 Mesh	
060523808M		80 Mesh	
0605238010M		100 Mesh	

YEDEK PARÇA / SPARE PARTS / REPUESTOS

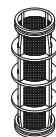

KOD CODE - CÓDIGO	Mesh	Süzgeç Cartridge Cartucho
06020530	30 Mesh	INOX
06020550	50 Mesh	
06020580	80 Mesh	
060205100	100 Mesh	

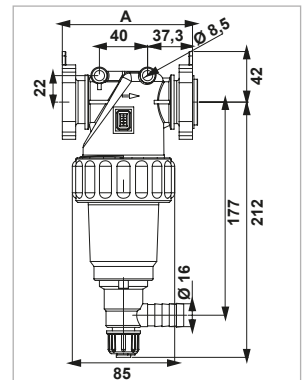

FLANŞ BAĞLANTILI HAT FİLTRESİ 280 LT (DÜZ MODEL)

- Flanş bağlantılı
- Max basınç: 20 bar
- Filtreleme kapasitesi 200+280 lt/dak
- Paslanmaz Inox süzgeç
- Çift taraflı bağlantı imkanı
- EPDM Oring (VITON® isteğe bağlı)



FLANGE CONNECTED LINE FILTER 280 LT

- Flange connected
- Max. operating pressure 20 bar
- Filtering capacity 200+280 l/min
- Stainless steel cartridge
- Can be fixed in both sides
- EPDM gaskets (VITON® optional)

FILTRO DE LÍNEA CON BRIDA CONECTADA 280 LT

- Con brida conectada
- Presión max: 20 bar
- Capacidad filtrante 200+280 l/min
- Cartucho de acero inox
- Puntos de fijación en ambos lados
- Juntas en EPDM (opcional, en VITON®)

KOD CODE - CÓDIGO	A (mm)	Mesh	Süzgeç Cartridge Cartucho
060522903	142	30 Mesh	INOX
060522905		50 Mesh	
060522908		80 Mesh	
060522910		100 Mesh	

YEDEK PARÇA / SPARE PARTS / REPUESTOS

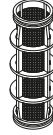

KOD CODE - CÓDIGO	Mesh	Süzgeç Cartridge Cartucho
06020630	30 Mesh	INOX
06020650	50 Mesh	
06020680	80 Mesh	
060206100	100 Mesh	

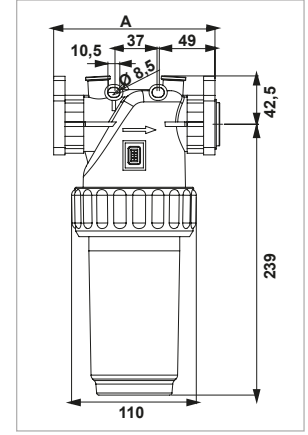

FLANŞ BAĞLANTILI HAT FİLTRESİ 280 LT (TAHLİYE VANALI MODEL)

- Flanş bağlantılı
- Max basınç: 20 bar
- Filtreleme kapasitesi 200+280 lt/dak
- Paslanmaz Inox süzgeç
- Çift taraflı bağlantı imkanı
- EPDM Oring (VITON® isteğe bağlı)



FLANGE CONNECTED LINE FILTER 280 LT (SELF - CLEANING)

- Flange connected
- Max. operating pressure 20 bar
- Filtering capacity 200+280 l/min
- Stainless steel cartridge
- Can be fixed in both sides
- EPDM gaskets (VITON® optional)

FILTRO DE LÍNEA CON BRIDA CONECTADA 280 LT (AUTOLIMPIANTES)

- Con brida conectada
- Presión max: 20 bar
- Capacidad filtrante 200+280 l/min
- Cartucho de acero inox
- Puntos de fijación en ambos lados
- Juntas en EPDM (opcional, en VITON®)

KOD CODE - CÓDIGO	A (mm)	Mesh	Süzgeç Cartridge Cartucho
060523903M	142	30 Mesh	INOX
060523905M		50 Mesh	
060523908M		80 Mesh	
060523910M		100 Mesh	

YEDEK PARÇA / SPARE PARTS / REPUESTOS

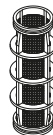

KOD CODE - CÓDIGO	Mesh	Süzgeç Cartridge Cartucho
06020630	30 Mesh	INOX
06020650	50 Mesh	
06020680	80 Mesh	
060206100	100 Mesh	

