

8

TURBO ATOMİZÖR PARÇALARI

MIST BLOWER ACCESSORIES
ACCESORIOS PARA ATOMIZADORES



8

AY BORU

- Turbo atomizör fanları için ay boru
- Malzeme: 21,3x2 mm AISI 304 paslanmaz çelik
- G ½" E paso bağlantısı



CURVED RODS

- Curved rods for orchard sprayers
- Material: 21,3x2 mm AISI 304 stainless steel
- G ½" M threaded fitting

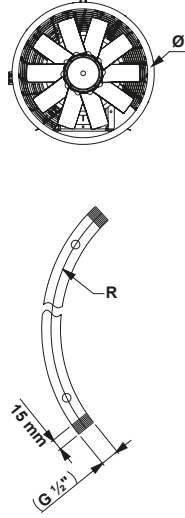

BARRAS CURVAS

- Barras curvas para atomizadores
- Material: 21,3x2 mm AISI 304 de acero
- G ½" M toma roscada

| TAKIM - KIT | Fan Ø (mm) | R (mm) | Delik Sayısı Holes Orificios | Delik Çapı Ø |
|-------------|------------|--------|------------------------------------|-----------------|
| 08001565 | 600 | 345 | 5 | 7 |
| 08001566 | | | 6 | |
| 08001575 | 700 | 395 | 5 | |
| 08001576 | | | 6 | |
| 08001577 | | | 7 | |
| 08001586 | 800 | 445 | 6 | |
| 08001587 | | | 7 | |
| 08001588 | | | 8 | |
| 08001596 | 900 | 495 | 6 | |
| 08001597 | | | 7 | |
| 08001598 | | | 8 | |
| 080015107 | 1000 | 545 | 7 | |
| 080015108 | | | 8 | |
| 080015109 | | | 9 | |

KELEPÇELİ AY BORU

- Turbo atomizör fanları için kelepçeli ay boru
- Malzeme: 21,3x2 mm AISI 304 paslanmaz çelik
- G ½" E paso bağlantısı (Bir tarafı piriç kör tapalı)
- G ¼" Dişi meme kelepçeleri dahildir



CURVED RODS WITH NOZZLE HOLDER CLAMPS

- Curved rods with nozzle holder clamps for orchard sprayers
- Material: 21,3x2 mm AISI 304 stainless steel
- G ½" M threaded fitting (With blanking cap by one side)
- G ¼" F Nozzle holders clamps are included

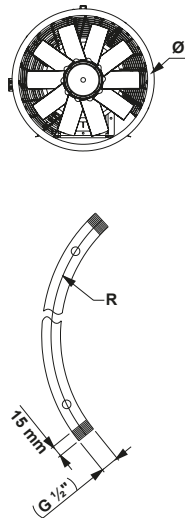

BARRAS CURVAS CON ABRAZADERA DE PORTABOQUILLAS

- Barras curvas con abrazadera de portaboquillas para atomizadores
- Material: 21,3x2 mm AISI 304 de acero
- G ½" M toma roscada (Con tapón hembra por una parte)
- G ¼" H abrazaderas de portaboquillas están incluidas

| TAKIM - KIT | Fan Ø (mm) | R (mm) | Meme Sayısı Nozzles Boquillas | G |
|-------------|------------|--------|-------------------------------------|------|
| 080016165 | 600 | 345 | 5 | G ¼" |
| 080016166 | | | 6 | |
| 080016175 | 700 | 395 | 5 | |
| 080016176 | | | 6 | |
| 080016177 | | | 7 | |
| 080016186 | 800 | 445 | 6 | |
| 080016187 | | | 7 | |
| 080016188 | | | 8 | |
| 080016196 | 900 | 495 | 6 | |
| 080016197 | | | 7 | |
| 080016198 | | | 8 | |
| 0800161107 | 1000 | 545 | 7 | |
| 0800161108 | | | 8 | |
| 0800161109 | | | 9 | |

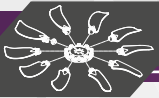
**8****AY BORU**

- Turbo atomizör fanları için ay boru
- Malzeme: 20x1,5 mm AISI 304 paslanmaz çelik
- G ½" E paso bağlantısı (Bir tarafı piriç kör tapalı)
- Piriç G ¼" dişi meme bağlantısı

**CURVED RODS**

- Curved rods for orchard sprayers
- Material: 20X1,5 mm AISI 304 stainless steel
- G ½" M threaded fitting
(One side with brass male plug)
- Brass G ¼" F nozzle connection

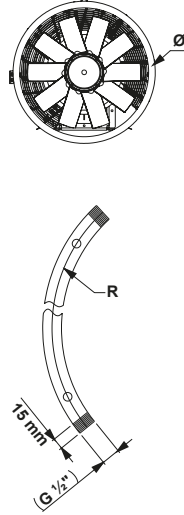
**BARRAS CURVAS**

- Barras curvas para atomizadores
- Material: 20X1,5 mm AISI 304 de acero
- G ½" M toma roscada
(Un lado con tapón macho de latón)
- Conexión de boquilla de latón G ¼" H

| TAKIM - KIT | Fan Ø (mm) | R (mm) | Meme Sayısı Nozzles Boquillas | G |
|-------------|------------|--------|-------------------------------------|------|
| 080016265 | 600 | 345 | 5 | G ¼" |
| 080016266 | | | 6 | |
| 080016275 | 700 | 395 | 5 | |
| 080016276 | | | 6 | |
| 080016277 | | | 7 | |
| 080016286 | 800 | 445 | 6 | |
| 080016287 | | | 7 | |
| 080016288 | | | 8 | |
| 080016296 | 900 | 495 | 6 | |
| 080016297 | | | 7 | |
| 080016298 | | | 8 | |
| 0800162107 | 1000 | 545 | 7 | |
| 0800162108 | | | 8 | |
| 0800162109 | | | 9 | |

AY BORU

- Turbo atomizör fanları için ay boru
- Malzeme: 20x1,5 mm AISI 304 paslanmaz çelik
- G ½" E paso bağlantısı (Bir tarafı piriç kör tapalı)
- Piriç G 3/8" dişi meme bağlantısı

**CURVED RODS**

- Curved rods for orchard sprayers
- Material: 20X1,5 mm AISI 304 stainless steel
- G ½" M threaded fitting
(One side with brass male plug)
- Brass G 3/8" F nozzle connection

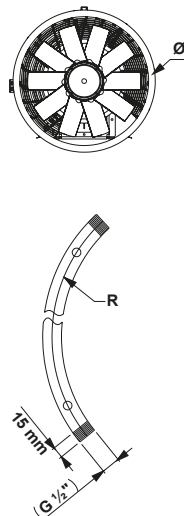
**BARRAS CURVAS**

- Barras curvas para atomizadores
- Material: 20X1,5 mm AISI 304 de acero
- G ½" M toma roscada
(Un lado con tapón macho de latón)
- Conexión de boquilla de latón G 3/8" H

| TAKIM - KIT | Fan Ø (mm) | R (mm) | Meme Sayısı Nozzles Boquillas | G |
|-------------|------------|--------|-------------------------------------|--------|
| 080016365 | 600 | 345 | 5 | G 3/8" |
| 080016366 | | | 6 | |
| 080016375 | 700 | 395 | 5 | |
| 080016376 | | | 6 | |
| 080016377 | | | 7 | |
| 080016386 | 800 | 445 | 6 | |
| 080016387 | | | 7 | |
| 080016388 | | | 8 | |
| 080016396 | 900 | 495 | 6 | |
| 080016397 | | | 7 | |
| 080016398 | | | 8 | |
| 0800163107 | 1000 | 545 | 7 | |
| 0800163108 | | | 8 | |
| 0800163109 | | | 9 | |



8

DÜZ BORU

- Krom düz boru
- Malzeme: 21,3x2 mm AISI 304 paslanmaz çelik
- Her iki tarafı G ½" E paso bağlantısı
- Ø 7 mm ve Ø 10 mm delik seçenekleri
- Kod, tekli ürün kodudur

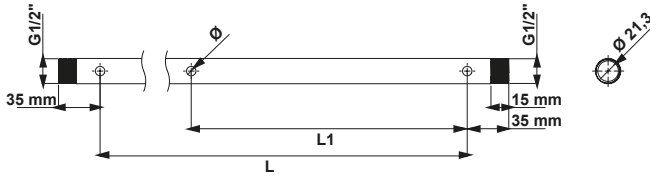

STRAIGHT ROD

- Stainless Steel Rod
- Material: 21,3x2 mm AISI 304 stainless steel
- G ½" M threaded fitting (Both side)
- Ø 7 mm and Ø 10 mm hole options
- Code is a single product code

BARRA RECTA

- Barra de acero inoxidable
- Material: 21,3x2 mm AISI 304 de acero
- G ½" M toma roscada (Ambos lados)
- Opciones de orificio de Ø 7 mm y Ø 10 mm
- El código es un código de producto único

| KOD CODE - CÓDIGO | L (mm) | L1 (mm) | Delik Sayısı Holes Orificios | Delik Çapı Ø (mm) |
|----------------------|-----------|------------|------------------------------------|----------------------|
| 080016663 | 600 | 265 | 3 | 7 |
| 080016683 | 800 | 365 | 3 | |
| 080016684 | 800 | 243 | 4 | |
| 0800166104 | 1000 | 310 | 4 | |
| 0800166105 | 1000 | 232 | 5 | |
| 0800166124 | 1200 | 376 | 4 | |
| 0800166125 | 1200 | 282 | 5 | |
| 0800166145 | 1400 | 332 | 5 | |
| 0800166155 | 1500 | 357 | 5 | |
| 0800166165 | 1600 | 382 | 5 | |
| 080016763 | 600 | 265 | 3 | 10 |
| 080016783 | 800 | 365 | 3 | |
| 080016784 | 800 | 243 | 4 | |
| 0800167104 | 1000 | 310 | 4 | |
| 0800167105 | 1000 | 232 | 5 | |
| 0800167124 | 1200 | 376 | 4 | |
| 0800167125 | 1200 | 282 | 5 | |
| 0800167145 | 1400 | 332 | 5 | |
| 0800167155 | 1500 | 357 | 5 | |
| 0800167165 | 1600 | 382 | 5 | |

DÜZ BORU

- Krom düz boru
- Malzeme: 21,3x2 mm AISI 304 paslanmaz çelik
- Her iki tarafı G ½" E paso bağlantısı
- Ø 7 mm ve Ø 10 mm delik seçenekleri
- Kod, tekli ürün kodudur

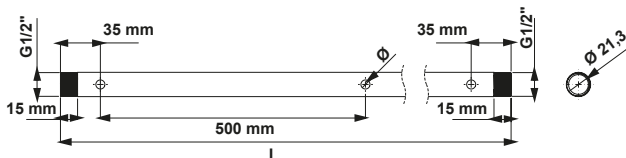

STRAIGHT ROD

- Stainless Steel Rod
- Material: 21,3x2 mm AISI 304 stainless steel
- G ½" M threaded fitting (Both side)
- Ø 7 mm and Ø 10 mm hole options
- Code is a single product code

BARRA RECTA

- Barra de acero inoxidable
- Material: 21,3x2 mm AISI 304 de acero
- G ½" M toma roscada (Ambos lados)
- Opciones de orificio de Ø 7 mm y Ø 10 mm
- El código es un código de producto único

| KOD CODE - CÓDIGO | L (mm) | Delik Sayısı Holes Orificios | Delik Çapı Ø (mm) |
|----------------------|-----------|------------------------------------|----------------------|
| 080016831 | 370 | 1 | 7 |
| 080016852 | 570 | 2 | |
| 0800168103 | 1070 | 3 | |
| 0800168154 | 1570 | 4 | |
| 0800168205 | 2070 | 5 | |
| 0800168256 | 2570 | 6 | |
| 0800168307 | 3070 | 7 | |
| 0800168358 | 3570 | 8 | |
| 0800168409 | 4070 | 9 | |
| 080016931 | 370 | 1 | |
| 080016952 | 570 | 2 | |
| 0800169103 | 1070 | 3 | |
| 0800169154 | 1570 | 4 | |
| 0800169205 | 2070 | 5 | |
| 0800169256 | 2570 | 6 | |
| 0800169307 | 3070 | 7 | |
| 0800169358 | 3570 | 8 | |
| 0800169409 | 4070 | 9 | |

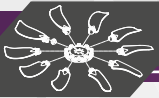
**8**

FAN IZGARALARI

- Turbo atomizör fanları için koruyucu ızgara
- Siyah kataforez kaplamalıdır

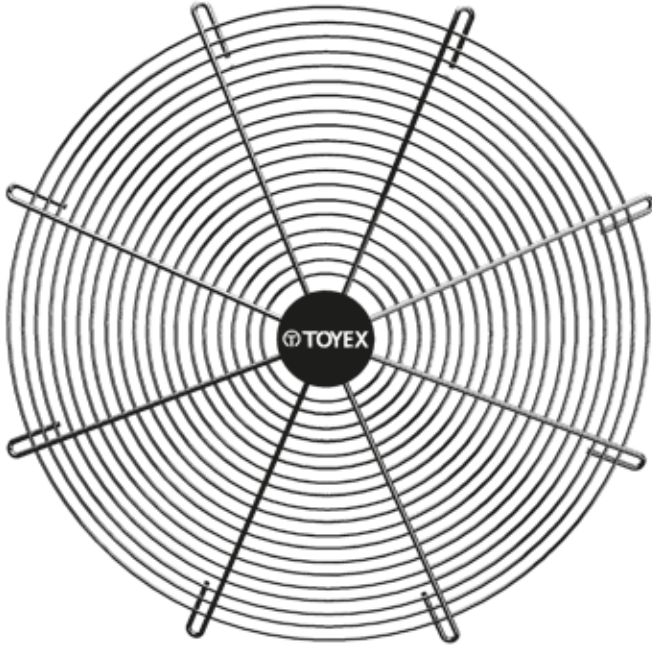

FAN PROTECTION GRID

- Fan protection grid for orchard sprayers
- Black cataphoresis coating

REJILLA DE PROTECCIÓN DE GRUPOS DE AIRE

- Rejillas de protección para grupos de aire
- Recubrimiento de cataforesis negro

| KOD CODE - CÓDIGO | A (mm) | Ø (mm) | Bağlantı Kanca Adedi Clamp - Abrazadera |
|----------------------|-----------|-----------|--|
| 08548600 | 600 | 500 | 8 |
| 08548700 | 700 | 600 | |
| 08548800 | 800 | 700 | |
| 08548900 | 900 | 800 | |
| 085481010 | 1010 | 900 | |
| 085481140 | 1140 | 1000 | |

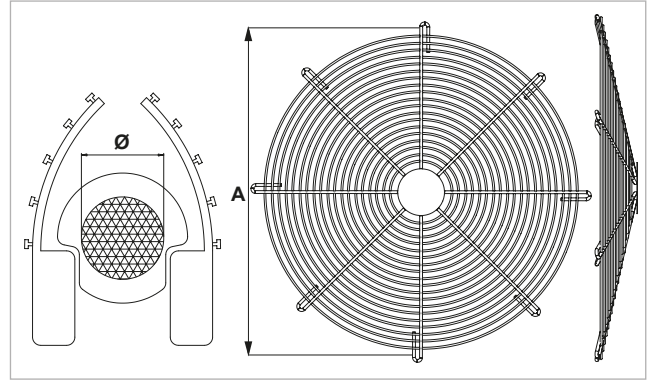

Farklı ölçü seçenekleri için firmamız ile irtibata geçiniz
Please contact our company for different size options / Comuníquese con nuestra empresa para conocer las diferentes opciones de tamaño

FAN DAVLUMBAZ

- Turbo atomizör fanları için
- AISI 304 paslanmaz çelik seçeneği
- DKP sac (Kaplamaşız) seçeneği

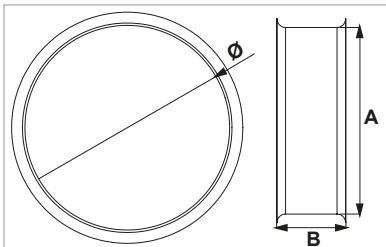

STAINLESS STEEL RING

- For orchard sprayers
- AISI 304 stainless steel options
- Heat treated steel sheet options (No coating)

CAMPANA INOXIDABLE

- Para grupos de aire
- Opción de AISI 304 acero de inoxidable
- Opción de acero tratado térmicamente (Sin recubrimiento)

| | KOD CODE - CÓDIGO | Ø (mm) | Ø (") | A (mm) | B (mm) |
|----------|----------------------|-----------|----------|-----------|-----------|
| AISI 304 | 0856000625SS | 600 | 24" | 630 | 250 |
| | 0857000625SS | 700 | 28" | 730 | 250 |
| | 0858000625SS | 800 | 32" | 830 | 250 |
| | 0859000625SS | 900 | 36" | 930 | 250 |
| | 0856000635SS | 600 | 24" | 630 | 350 |
| | 0857000635SS | 700 | 28" | 730 | 350 |
| | 0858000635SS | 800 | 32" | 830 | 350 |
| | 0859000635SS | 900 | 36" | 930 | 350 |
| | 0860100035SS | 1000 | 41" | 1060 | 350 |

| | KOD CODE - CÓDIGO | Ø (mm) | Ø (") | A (mm) | B (mm) |
|-----|----------------------|-----------|----------|-----------|-----------|
| DKP | 0856000625DKPS | 600 | 24" | 630 | 250 |
| | 0857000625DKPS | 700 | 28" | 730 | 250 |
| | 0858000625DKPS | 800 | 32" | 830 | 250 |
| | 0859000625DKPS | 900 | 36" | 930 | 250 |
| | 0856000635DKPS | 600 | 24" | 630 | 350 |
| | 0857000635DKPS | 700 | 28" | 730 | 350 |
| | 0858000635DKPS | 800 | 32" | 830 | 350 |
| | 0859000635DKPS | 900 | 36" | 930 | 350 |
| | 0860100035DKPS | 1000 | 41" | 1060 | 350 |



8

TURBO MEME KELEPÇESİ
NOZZLE HOLDER CLAMP
ABRAZADERA DE PORTAQUILLAS

- Montaj vidaları dahildir
- With fixing screws
- Con tornillos de montaje

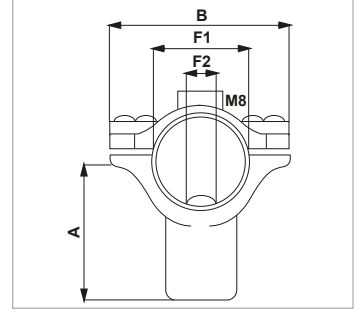

| KOD - CODE - CÓDIGO | G | F1 | F2 | F3 | A | B |
|---------------------|--------|-------|----|----|------|----|
| 08200500 | G 1/4" | Ø20 | Ø7 | - | 27,5 | 42 |
| 08201000 | | Ø21,3 | | - | 27,5 | |
| 08201500 | | Ø20 | | - | 35 | |
| 08202000 | | Ø21,3 | | - | 35 | |
| 08202500 | | Ø21,3 | | M8 | 27,5 | |
| 08203000 | | Ø21,3 | | M8 | 35 | |

SABİT KANAT GÖBEĞİ



AIR DISTRUBİTOR HUB

NÚCLEO DE DISTRIBUIDOR DE AIRE

| KOD CODE - CÓDIGO | Renk - Color |
|----------------------|----------------------------|
| 08300001 | Kırmızı - Red - Rojo |
| 08300001M | Mavi - Blue - Azul |
| 08300001S | Siyah - Black - Negro |
| 08300001T | Turuncu - Orange - Naranja |
| 08300001Y | Yeşil - Green - Verde |



Diğer renk seçenekleri için lütfen irtibata geçiniz.
Other colors upon request. / A pedido están disponibles otros colores.

SERAMİK PLAKETLER
CERAMIC PLATES
PLACAS DE CERÁMICA

| D: 15 mm | D: 18 mm | Ø (mm) |
|----------|----------|--------|
| 08010008 | 08011808 | 0,8 |
| 08010010 | 08011810 | 1,0 |
| 08010012 | 08011812 | 1,2 |
| 08010015 | 08011815 | 1,5 |
| 08010018 | 08011818 | 1,8 |
| 08010020 | 08011820 | 2,0 |
| 08010025 | 08011825 | 2,5 |

SÜZGEÇ
FILTER
FILTRO

| D: 15 mm | D: 17 mm |
|----------|----------|
| 08020000 | 08020001 |

GİRDAP DİSKİ
CONVEYOR
CONDUCTOR

| D: 15 mm | D: 17 mm | Ø (mm) |
|----------|----------|--------|
| 08040101 | 08040001 | - |
| 08040110 | 08040010 | 1,0 |
| 08040112 | 08040012 | 1,2 |
| 08040115 | 08040015 | 1,5 |

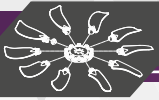
**8****İLAÇLAMA TABANCASI (KISA)**
HANDLE SPRAY GUN
PISTOLA PULVERIZADORA

| KOD - CODE - CÓDIGO | mm |
|---------------------|-----|
| 08051000 | 360 |

İLAÇLAMA TABANCASI (UZUN)
HANDLE SPRAY GUN
PISTOLA PULVERIZADORA

| KOD - CODE - CÓDIGO | mm |
|---------------------|-----|
| 08051001 | 500 |

İLAÇLAMA TABANCASI TETİKLİ (KISA)
TRIGGER SPRAY GUN
PISTOLA PULVERIZADORA DE PALANCA

| KOD - CODE - CÓDIGO | mm |
|---------------------|-----|
| 08051002 | 330 |

İLAÇLAMA TABANCASI TETİKLİ (UZUN)
TRIGGER SPRAY GUN
PISTOLA PULVERIZADORA DE PALANCA

| KOD - CODE - CÓDIGO | mm |
|---------------------|-----|
| 08051003 | 600 |

İLAÇLAMA TABANCASI TETİKLİ (ECO)
TRIGGER SPRAY GUN
PISTOLA PULVERIZADORA DE PALANCA

| KOD - CODE - CÓDIGO | mm |
|---------------------|-----|
| 08051004 | 240 |

İLAÇLAMA TABANCASI TETİKLİ (YABANCI OT İLAÇLAMA)
TRIGGER SPRAY GUN
PISTOLA PULVERIZADORA DE PALANCA

| KOD - CODE - CÓDIGO | mm |
|---------------------|------|
| 08051005 | 1000 |

İLAÇLAMA TABANCASI TETİKLİ
TRIGGER SPRAY GUN
PISTOLA PULVERIZADORA DE PALANCA

| KOD - CODE - CÓDIGO | mm |
|---------------------|-----|
| 08051006 | 250 |

TABANCA UCU
NOZZLE WITH CERAMIC INSERT
BOQUILLA CON INSERTO DE CERÁMICA

| KOD - CODE - CÓDIGO | Ø (mm) |
|---------------------|--------|
| 08060010 | 1,0 |
| 08060012 | 1,2 |
| 08060015 | 1,5 |
| 08060018 | 1,8 |
| 08060020 | 2,0 |
| 08060025 | 2,5 |
| 08060030 | 3,0 |

DÖNER NİPEL
SWIVEL FITTING
RACOR GIRATORIO

| KOD - CODE - CÓDIGO | F |
|---------------------|------|
| 08051050 | G ½" |

L - DÖNER NİPEL
L - SWIVEL FITTING
RACOR GIRATORIO

| KOD - CODE - CÓDIGO | F |
|---------------------|------|
| 09033913 | G ½" |

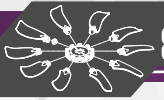

8

BORA 230
AYARLI PERVANE DÜZ

- Yüksek Dayanımlı Plastik Gövde ve Kanatlar
- 5 Farklı Ayar Seçeneği
- Pervane Dönüş Yönü: Sol - Sağ
- Maksimum Traktör Gücü 55 Beygir

| | |
|--------------|------------------|
| Pervane Çapı | 28", 32", 36" |
| Kanat Tipi | Seri 1 Düz Kanat |
| Göbek Tipi | Küçük Göbek |
| Göbek Çapı | 230 mm |

BORA 230
ADJUSTABLE FAN

- Glass Reinforced Polyamide Hub And Blades
- Adjustable Blades
- Rotation Direction: Counterclockwise - Clockwise
- Maximum Tractor Power 55 HP

| | |
|--------------|---------------|
| Diameter | 28", 32", 36" |
| Blade Type | Type 1 |
| Hub Type | Small Hub |
| Hub Diameter | 230 mm |

BORA 230
VENTILADOR REGULABLE

- Aletas y Núcleo de polimida reforzada con fibra de vidrio
- Aletas regulables
- La dirección de giro: Izquierda - Derecha
- La potencia máxima del tractor 55 HP

| | |
|--------------------|----------------|
| Diámetro | 28", 32", 36" |
| Tipo de Aletas | Tipo 1 |
| Tipo de Núcleo | Núcleo Pequeño |
| Diámetro de Núcleo | 230 mm |

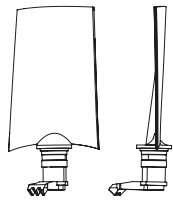

| KOD CODE - CÓDIGO | D | Yön Direction Dirección | Renk Color |
|----------------------|-----|-------------------------------|-------------------------|
| KP1P08CW28B | 28" | Sol Left Izquierda | Siyah Black Negro |
| KP1P08CW32B | 32" | | |
| KP1P08CW36B | 36" | | |
| KP1P08C28B | 28" | Sağ Right Derecha | |
| KP1P08C32B | 32" | | |
| KP1P08C36B | 36" | | |

YEDEK PARÇA / SPARE PARTS / REPUESTOS

| KOD CODE - CÓDIGO | L | Yön Direction Dirección | Renk Color |
|----------------------|--------|-------------------------------|-------------------------|
| 08101002CW | 240 mm | Sol Left Izquierda | Siyah Black Negro |
| 08101011CW | 290 mm | | |
| 08101021CW | 325 mm | | |
| 08101002C | 240 mm | Sağ Right Derecha | |
| 08101011C | 290 mm | | |
| 08101021C | 325 mm | | |

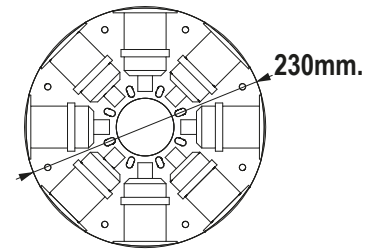

Ayar Anahtarı
Adjustment Lock Tool
Herramienta de ajuste

08110001



Pervane Flanşı (Küçük)
Flange
Brida

08110002



Göbek Komple (Küçük)
Hub With All Parts
Núcleo Completo

Yön
Direction
Dirección

Renk
Color

| | | |
|------------|-------------------------|--------------------------|
| 08101006 | Sol - Left Izquierda | Kırmızı - Red - Rojo |
| 08101006S | | Sarı - Yellow - Amarillo |
| 08101006C | Sağ - Right Derecha | Kırmızı - Red - Rojo |
| 08101006CS | | Sarı - Yellow - Amarillo |

Ayar anahtarı ayrıca sipariş edilmelidir
Adjustment tool must be ordered separately
Llave de ajuste debe pedirse por separado

Flanş göbekleri işlenmemiştir
Not machined according to gearbox
El núcleo de brida no mecanizado



BORA 300 AYARLI PERVANE DÜZ

- Yüksek Dayanımlı Plastik Gövde ve Kanatlar
- 5 Farklı Ayar Seçeneği
- Pervane Dönüş Yönü: Sol - Sağ
- Maksimum Traktör Gücü 55 Beygir

| | |
|--------------|------------------|
| Pervane Çapı | 36" |
| Kanat Tipi | Seri 1 Düz Kanat |
| Göbek Tipi | Büyük Göbek |
| Göbek Çapı | 300 mm |

BORA 300 ADJUSTABLE FAN

- Glass Reinforced Polyamide Hub And Blades
- Adjustable Blades
- Rotation Direction: Counterclockwise - Clockwise
- Maximum Tractor Power 55 HP

| | |
|--------------|---------|
| Diameter | 36" |
| Blade Type | Type 1 |
| Hub Type | Big Hub |
| Hub Diameter | 300 mm |

BORA 300 VENTILADOR REGULABLE

- Aletas y Núcleo de polimida reforzada con fibra de vidrio
- Aletas regulables
- La dirección de giro: Izquierda - Derecha
- La potencia máxima del tractor 55 HP

| | |
|--------------------|---------------|
| Diámetro | 36" |
| Tipo de Aletas | Tipo 1 |
| Tipo de Núcleo | Núcleo Grande |
| Diámetro de Núcleo | 300 mm |



| KOD CODE - CÓDIGO | D | Yön Direction Dirección | Renk Color |
|----------------------|-----|-------------------------------|--------------------------|
| BP1P08CW36B | 36" | Sol - Left Izquierda | Siyah - Black - Negro |
| BP1P08CW36S | | | Sarı - Yellow - Amarillo |
| BP1P08C36B | | Sağ - Right Derecha | Siyah - Black - Negro |
| BP1P08C36S | | | Sarı - Yellow - Amarillo |

YEDEK PARÇA / SPARE PARTS / REPUESTOS

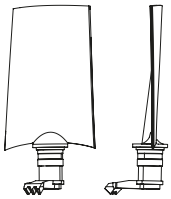

| KOD CODE - CÓDIGO | L | Yön Direction Dirección | Renk Color |
|----------------------|--------|-------------------------------|--------------------------|
| 08101011CWS | 290 mm | Sol - Left Izquierda | Sarı - Yellow - Amarillo |
| 08101011CW | | | Siyah - Black - Negro |
| 08101011CS | | Sağ - Right Derecha | Sarı - Yellow - Amarillo |
| 08101011C | | | Siyah - Black - Negro |

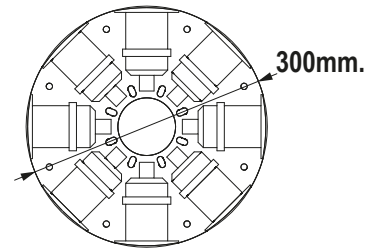

Ayar Anahtarı
Adjustment Lock Tool
Herramienta de ajuste

08110001



Pervane Flanşı (Büyük)
Flange
Brida

08110003



| Göbek Komple (Büyük) Hub With All Parts Núcleo Completo | Yön Direction Dirección | Renk Color |
|---|-------------------------------|--------------------------|
| 08101007 | Sol - Left Izquierda | Kırmızı - Red - Rojo |
| 08101007S | | Sarı - Yellow - Amarillo |
| 08101007C | Sağ - Right Derecha | Kırmızı - Red - Rojo |
| 08101007CS | | Sarı - Yellow - Amarillo |

Ayar anahtarı ayrıca sipariş edilmelidir
Adjustment tool must be ordered separately
Llave de ajuste debe pedirse por separado

Flanş göbekleri işlenmemiştir
Not machined according to gearbox
El núcleo de brida no mecanizado



TAYFUN 230 AYARLI PERVANE EĞİMLİ

- Yüksek Dayanımlı Plastik Gövde ve Kanatlar
- 5 Farklı Ayar Seçeneği
- Pervane Dönüş Yönü: Sol - Sağ
- Maksimum Traktör Gücü 55 Beygir

| | |
|--------------|---------------------|
| Pervane Çapı | 32" |
| Kanat Tipi | Seri 2 Eğimli Kanat |
| Göbek Tipi | Küçük Göbek |
| Göbek Çapı | 230 mm |

TAYFUN 230 ADJUSTABLE FAN

- Glass Reinforced Polyamide Hub And Blades
- Adjustable Blades
- Rotation Direction: Counterclockwise - Clockwise
- Maximum Tractor Power 55 HP

| | |
|--------------|-----------|
| Diameter | 32" |
| Blade Type | Type 2 |
| Hub Type | Small Hub |
| Hub Diameter | 230 mm |

TAYFUN 230 VENTILADOR REGULABLE

- Aletas y Núcleo de polimiada reforzada con fibra de vidrio
- Aletas regulables
- La dirección de giro: Izquierda - Derecha
- La potencia máxima del tractor 55 HP

| | |
|--------------------|----------------|
| Diámetro | 32" |
| Tipo de Aletas | Tipo 2 |
| Tipo de Núcleo | Núcleo Pequeño |
| Diámetro de Núcleo | 230 mm |



| KOD CODE - CÓDIGO | D | Yön Direction Dirección | Renk Color |
|----------------------|-----|-------------------------------|----------------------------|
| KP2P08CW32B | 32" | Sol - Left Izquierda | Siyah - Black - Negro |
| KP2P08CW32S | | | Sarı - Yellow - Amarillo |
| KP2P08CW32T | | | Turuncu - Orange - Naranja |
| KP2P08C32B | | Sağ - Right Derecha | Siyah - Black - Negro |
| KP2P08C32S | | | Sarı - Yellow - Amarillo |
| KP2P08C32T | | | Turuncu - Orange - Naranja |

YEDEK PARÇA / SPARE PARTS / REPUESTOS

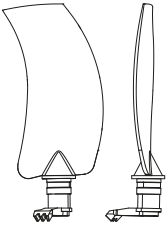

| KOD CODE - CÓDIGO | L | Yön Direction Dirección | Renk Color |
|----------------------|--------|-------------------------------|----------------------------|
| 08101011CW1 | 290 mm | Sol - Left Izquierda | Siyah - Black - Negro |
| 08101011CW1S | | | Sarı - Yellow - Amarillo |
| 08101011CW1T | | | Turuncu - Orange - Naranja |
| 08101011C1 | | Sağ - Right Derecha | Siyah - Black - Negro |
| 08101011C1S | | | Sarı - Yellow - Amarillo |
| 08101011C1T | | | Turuncu - Orange - Naranja |

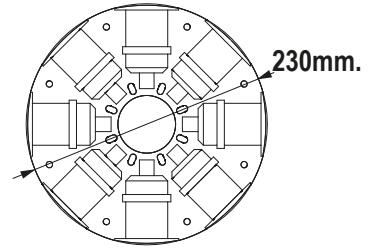

Ayar Anahtarı
Adjustment Lock Tool
Herramienta de ajuste

08110001



Pervane Flanşı (Küçük)
Flange
Brida

08110002



Göbek Komple (Küçük)
Hub With All Parts
Núcleo Completo

Yön
Direction
Dirección

Renk
Color

08101006

08101006S

08101006T

08101006C

08101006CS

08101006CT

Sol - Left
Izquierda

Sağ - Right
Derecha

Kırmızı - Red - Rojo

Sarı - Yellow - Amarillo

Turuncu - Orange - Naranja

Kırmızı - Red - Rojo

Sarı - Yellow - Amarillo

Turuncu - Orange - Naranja

Ayar anahtarı ayrıca sipariş edilmelidir
Adjustment tool must be ordered separately
Llave de ajuste debe pedirse por separado

Flanş göbekleri işlenmemiştir
Not machined according to gearbox
El núcleo de brida no mecanizado

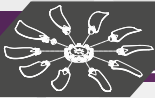

8

TURBO ATOMİZÖR PARÇALARI
MIST BLOWER ACCESSORIES / ACCESORIOS PARA ATOMIZADORES**TOYMAN®**

TAYFUN 300 AYARLI PERVANE EĞİMLİ

- Yüksek Dayanımlı Plastik Gövde ve Kanatlar
- 5 Farklı Ayar Seçeneği
- Pervane Dönüş Yönü: Sol - Sağ
- Maksimum Traktör Gücü 55 Beygir

| | |
|--------------|---------------------|
| Pervane Çapı | 36" |
| Kanat Tipi | Seri 2 Eğimli Kanat |
| Göbek Tipi | Büyük Göbek |
| Göbek Çapı | 300 mm |

TAYFUN 300 ADJUSTABLE FAN

- Glass Reinforced Polyamide Hub And Blades
- Adjustable Blades
- Rotation Direction: Counterclockwise - Clockwise
- Maximum Tractor Power 55 HP

| | |
|--------------|---------|
| Diameter | 36" |
| Blade Type | Type 2 |
| Hub Type | Big Hub |
| Hub Diameter | 300 mm |

TAYFUN 300 VENTILADOR REGULABLE

- Aletas y Núcleo de polimida reforzada con fibra de vidrio
- Aletas regulables
- La dirección de giro: Izquierda - Derecha
- La potencia máxima del tractor 55 HP

| | |
|--------------------|---------------|
| Diámetro | 36" |
| Tipo de Aletas | Tipo 2 |
| Tipo de Núcleo | Núcleo Grande |
| Diámetro de Núcleo | 300 mm |



| KOD CODE - CÓDIGO | D | Yön Direction Dirección | Renk Color |
|----------------------|-----|-------------------------------|----------------------------|
| BP2P08CW36B | 36" | Sol - Left Izquierda | Siyah - Black - Negro |
| BP2P08CW36S | | | Sarı - Yellow - Amarillo |
| BP2P08CW36T | | | Turuncu - Orange - Naranja |
| BP2P08C36B | | Sağ - Right Derecha | Siyah - Black - Negro |
| BP2P08C36S | | | Sarı - Yellow - Amarillo |
| BP2P08C36T | | | Turuncu - Orange - Naranja |

YEDEK PARÇA / SPARE PARTS / REPUESTOS

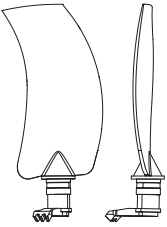

| KOD CODE - CÓDIGO | L | Yön Direction Dirección | Renk Color |
|----------------------|--------|-------------------------------|----------------------------|
| 08101011CW1 | 290 mm | Sol - Left Izquierda | Siyah - Black - Negro |
| 08101011CW1S | | | Sarı - Yellow - Amarillo |
| 08101011CW1T | | | Turuncu - Orange - Naranja |
| 08101011C1 | | Sağ - Right Derecha | Siyah - Black - Negro |
| 08101011C1S | | | Sarı - Yellow - Amarillo |
| 08101011C1T | | | Turuncu - Orange - Naranja |

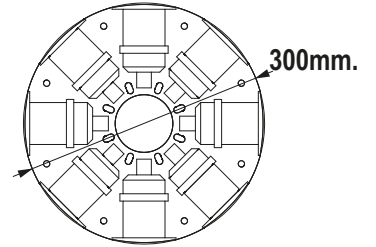

Ayar Anahtarı
Adjustment Lock Tool
Herramienta de ajuste

08110001



Pervane Flanşı (Büyük)
Flange
Brida

08110003



Göbek Komple (Büyük)
Hub With All Parts
Núcleo Completo

Yön
Direction
Dirección

Renk
Color

08101007

08101007S

08101007T

08101007C

08101007CS

08101007CT

Sol - Left
IzquierdaSağ - Right
Derecha

Kırmızı - Red - Rojo

Sarı - Yellow - Amarillo

Turuncu - Orange - Naranja

Kırmızı - Red - Rojo

Sarı - Yellow - Amarillo

Turuncu - Orange - Naranja

Ayar anahtarı ayrıca sipariş edilmelidir
Adjustment tool must be ordered separately
Llave de ajuste debe pedirse por separado

Flanş göbekleri işlenmemiştir
Not machined according to gearbox
El núcleo de brida no mecanizado



8

VENTO 250
ALÜMİNYUM PERVANE

- Alüminyum Gövde ve Yüksek Dayanımlı Plastik Kanatlar
- 30° / 45° / 60° Açı Seçenekleri
- Pervane Dönüş Yönü: Sol
- Traktör Güç Aralığı 55 - 95 Beygir

| | |
|---------------------|--------------------|
| Pervane Çapı | 32" |
| Kanat Tipi | Tip 4 Kanat |
| Göbek Çapı | 250 mm |

VENTO 250
ALUMINIUM HUB FAN

- Aluminium Hub and Glass Reinforced Polyamide Blades
- 30° / 45° / 60° Pitch Angle Options
- Rotation Direction: Counterclockwise
- Tractor Power Range 55 - 95 HP

| | |
|---------------------|---------------|
| Diameter | 32" |
| Blade Type | Type 4 |
| Hub Diameter | 250 mm |

VENTO 250 VENTILADOR
CON NÚCLEO DE ALUMINIO

- Núcleo de aluminio y aletas de polimiada reforzada con fibra de vidrio
- Opciones de ángulos 30° / 45° / 60°
- La dirección de giro: Izquierda
- La potencia máxima del tractor 55 - 95 HP

| | |
|---------------------------|---------------|
| Diámetro | 32" |
| Tipo de Aletas | Tipo 4 |
| Diámetro de Núcleo | 250 mm |



| KOD CODE - CÓDIGO | Balatalı - With Clutch Con Embrague | D | Açı Angle Ángulo | Yön Direction Dirección | Renk Color |
|----------------------|--|-----|------------------------|-------------------------------|---------------|
| KA4AP10CW3032T | KA4AP10CW3032TC | 32" | 30° | Sol | Turuncu |
| KA4AP10CW4532T | KA4AP10CW4532TC | | 45° | Left | Orange |
| KA4AP10CW6032T | KA4AP10CW6032TC | | 60° | Izquierda | Naranja |

YEDEK PARÇA / SPARE PARTS / REPUESTOS

| KOD CODE - CÓDIGO | L | Yön Direction Dirección | Renk Color |
|----------------------|--------|-------------------------------|-----------------------------|
| 08101213CW32 | 280 mm | Sol - Left Izquierda | Turuncu Orange - Naranja |



ANEMOS 250 ALÜMİNYUM PERVANE DÜZ

- Alüminyum Gövde ve Yüksek Dayanımlı Plastik Kanatlar
- 30° / 45° / 60° Açı Seçenekleri
- Pervane Dönüş Yönü: Sol - Sağ
- Traktör Güç Aralığı 55 - 95 Beygir

| | |
|--------------|-----------------|
| Pervane Çapı | 28", 32", 36" |
| Kanat Tipi | Tip 1 Düz Kanat |
| Göbek Çapı | 250 mm |

ANEMOS 250 ALUMINIUM HUB FAN

- Aluminium Hub and Glass Reinforced Polyamide Blades
- 30° / 45° / 60° Pitch Angle Options
- Rotation Direction: Counterclockwise - Clockwise
- Tractor Power Range 55 - 95 HP

| | |
|--------------|---------------|
| Diameter | 28", 32", 36" |
| Blade Type | Type 1 |
| Hub Diameter | 250 mm |

ANEMOS 250 VENTILADOR CON NÚCLEO DE ALUMINIO

- Núcleo de aluminio y aletas de polimida reforzada con fibra de vidrio
- Opciones de ángulos 30° / 45° / 60°
- La dirección de giro: Izquierda - Derecha
- La potencia máxima del tractor 55 - 95 HP

| | |
|--------------------|---------------|
| Diámetro | 28", 32", 36" |
| Tipo de Aletas | Tipo 1 |
| Diámetro de Núcleo | 250 mm |



| KOD CODE - CÓDIGO | Balatalı - With Clutch Con Embrague | D | Açı Angle Ángulo | Yön Direction Dirección | Renk Color | |
|----------------------|--|-----|------------------------|-------------------------------|------------------------|------------------------|
| KA1AP10CW3028K | KA1AP10CW3028KC | 28" | 30° | Sol Left Izquierda | Kırmızı Red Rojo | |
| KA1AP10CW4528K | KA1AP10CW4528KC | | 45° | | | |
| KA1AP10CW6028K | KA1AP10CW6028KC | | 60° | | | |
| KA1AP10CW3032K | KA1AP10CW3032KC | 32" | 30° | | | |
| KA1AP10CW4532K | KA1AP10CW4532KC | | 45° | | | |
| KA1AP10CW6032K | KA1AP10CW6032KC | | 60° | | | |
| KA1AP10CW3036K | KA1AP10CW3036KC | 36" | 30° | | | |
| KA1AP10CW4536K | KA1AP10CW4536KC | | 45° | | | |
| KA1AP10CW6036K | KA1AP10CW6036KC | | 60° | | | |
| KA1AP10C3028K | KA1AP10C3028KC | 28" | 30° | Sağ Right Derecha | | Kırmızı Red Rojo |
| KA1AP10C4528K | KA1AP10C4528KC | | 45° | | | |
| KA1AP10C6028K | KA1AP10C6028KC | | 60° | | | |
| KA1AP10C3032K | KA1AP10C3032KC | 32" | 30° | | | |
| KA1AP10C4532K | KA1AP10C4532KC | | 45° | | | |
| KA1AP10C6032K | KA1AP10C6032KC | | 60° | | | |
| KA1AP10C3036K | KA1AP10C3036KC | 36" | 30° | | | |
| KA1AP10C4536K | KA1AP10C4536KC | | 45° | | | |
| KA1AP10C6036K | KA1AP10C6036KC | | 60° | | | |

YEDEK PARÇA / SPARE PARTS / REPUESTOS

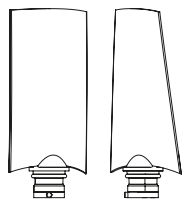

| KOD CODE - CÓDIGO | L | Yön Direction Dirección | Renk Color |
|----------------------|--------|-------------------------------|------------------------|
| 08101210CW28 | 240 mm | Sol Left Izquierda | Kırmızı Red Rojo |
| 08101210CW32 | 290 mm | | |
| 08101210CW36 | 325 mm | | |
| 08101210C28 | 240 mm | Sağ Right Derecha | |
| 08101210C32 | 290 mm | | |
| 08101210C36 | 325 mm | | |

Pervanelerimiz min. Ø 700 mm - Max. Ø 950 mm çaplarına kadar mevcuttur. Diğer renk ve ölçü seçenekleri için lütfen firmamız ile irtibata geçiniz.
Available dimensions between Ø 700 mm - Ø 950 mm. Please contact with us for other colour and size options.
Disponibles las dimensiones entre min. Ø 700 mm - max. Ø 950 mm. Póngase en contacto con nuestra empresa para otras opciones de color y tamaño.



8

TURBO ATOMİZÖR PARÇALARI
MIST BLOWER ACCESSORIES / ACCESORIOS PARA ATOMIZADORES**TOYMAN®**

ANEMOS 250 ALÜMİNYUM PERVANE DÜZ / 8 KANAT

- Alüminyum Gövde ve Yüksek Dayanımlı Plastik Kanatlar
- 30° / 45° / 60° Açı Seçenekleri
- Pervane Dönüş Yönü: Sol - Sağ
- Traktör Güç Aralığı 55 - 95 Beygir

| | |
|--------------|-----------------|
| Pervane Çapı | 28", 32", 36" |
| Kanat Tipi | Tip 1 Düz Kanat |
| Göbek Çapı | 250 mm |

ANEMOS 250 ALUMINIUM HUB FAN

- Aluminium Hub and Glass Reinforced Polyamide Blades
- 30° / 45° / 60° Pitch Angle Options
- Rotation Direction: Counterclockwise - Clockwise
- Tractor Power Range 55 - 95 HP

| | |
|--------------|---------------|
| Diameter | 28", 32", 36" |
| Blade Type | Type 1 |
| Hub Diameter | 250 mm |

ANEMOS 250 VENTILADOR CON NÚCLEO DE ALUMINIO

- Núcleo de aluminio y aletas de polimida reforzada con fibra de vidrio
- Opciones de ángulos 30° / 45° / 60°
- La dirección de giro: Izquierda - Derecha
- La potencia máxima del tractor 55 - 95 HP

| | |
|--------------------|---------------|
| Diámetro | 28", 32", 36" |
| Tipo de Aletas | Tipo 1 |
| Diámetro de Núcleo | 250 mm |



| KOD CODE - CÓDIGO | D | Açı Angle Ángulo | Yön Direction Dirección | Renk Color |
|----------------------|-----|------------------------|-------------------------------|------------------------|
| KA1AP08CW3028K | 28" | 30° | Sol Left Izquierda | Kırmızı Red Rojo |
| KA1AP08CW4528K | | 45° | | |
| KA1AP08CW6028K | | 60° | | |
| KA1AP08CW3032K | 32" | 30° | | |
| KA1AP08CW4532K | | 45° | | |
| KA1AP08CW6032K | | 60° | | |
| KA1AP08CW3036K | 36" | 30° | | |
| KA1AP08CW4536K | | 45° | | |
| KA1AP08CW6036K | | 60° | | |
| KA1AP08C3028K | 28" | 30° | Sağ Right Derecha | |
| KA1AP08C4528K | | 45° | | |
| KA1AP08C6028K | | 60° | | |
| KA1AP08C3032K | 32" | 30° | | |
| KA1AP08C4532K | | 45° | | |
| KA1AP08C6032K | | 60° | | |
| KA1AP08C3036K | 36" | 30° | | |
| KA1AP08C4536K | | 45° | | |
| KA1AP08C6036K | | 60° | | |

YEDEK PARÇA / SPARE PARTS / REPUESTOS

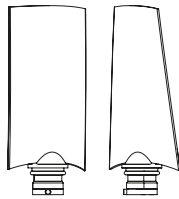

| KOD CODE - CÓDIGO | L | Yön Direction Dirección | Renk Color |
|----------------------|--------|-------------------------------|------------------------|
| 08101210CW28 | 240 mm | Sol Left Izquierda | Kırmızı Red Rojo |
| 08101210CW32 | 290 mm | | |
| 08101210CW36 | 325 mm | | |
| 08101210C28 | 240 mm | Sağ Right Derecha | |
| 08101210C32 | 290 mm | | |
| 08101210C36 | 325 mm | | |

Pervanelerimiz min. Ø 700 mm - Max. Ø 950 mm çaplarına kadar mevcuttur. Diğer renk ve ölçü seçenekleri için lütfen firmamız ile irtibata geçiniz.
Available dimensions between Ø 700 mm - Ø 950 mm. Please contact with us for other colour and size options.
Disponibles las dimensiones entre min. Ø 700 mm - max. Ø 950 mm. Póngase en contacto con nuestra empresa para otras opciones de color y tamaño.

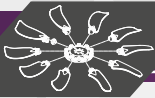

8

ANEMOS 330 ALÜMİNYUM PERVA NE DÜZ

- Alüminyum Gövde ve Yüksek Dayanımlı Plastik Kanatlar
- 30° / 45° / 60° Açı Seçenekleri
- Pervane Dönüş Yönü: Sol
- Traktör Güç Aralığı 55 - 95 Beygir

| | |
|--------------|-----------------|
| Pervane Çapı | 41" |
| Kanat Tipi | Tip 1 Düz Kanat |
| Göbek Çapı | 330 mm |

ANEMOS 330 ALUMINIUM HUB FAN

- Aluminium Hub and Glass Reinforced Polyamide Blades
- 30° / 45° / 60° Pitch Angle Options
- Rotation Direction: Counterclockwise
- Tractor Power Range 55 - 95 HP

| | |
|--------------|--------|
| Diameter | 41" |
| Blade Type | Type 1 |
| Hub Diameter | 330 mm |

ANEMOS 330 VENTILADOR CON NÚCLEO DE ALUMINIO

- Núcleo de aluminio y aletas de polimida reforzada con fibra de vidrio
- Opciones de ángulos 30° / 45° / 60°
- La dirección de giro: Izquierda
- La potencia máxima del tractor 55 - 95 HP

| | |
|--------------------|--------|
| Diámetro | 41" |
| Tipo de Aletas | Tipo 1 |
| Diámetro de Núcleo | 330 mm |



| KOD CODE - CÓDIGO | Balatalı - With Clutch Con Embrague | D | Açı Angle Ángulo | Yön Direction Dirección | Renk Color |
|----------------------|--|-----|------------------------|-------------------------------|------------------------------|
| BA1AP10CW3041T | BA1AP10CW3041TC | 41" | 30° | Sol Left Izquierda | Turuncu Orange Naranja |
| BA1AP10CW4541T | BA1AP10CW4541TC | | 45° | | |
| BA1AP10CW6041T | BA1AP10CW6041TC | | 60° | | |
| BA1AP10CW3041B | BA1AP10CW3041BC | | 30° | | Siyah Black Negro |
| BA1AP10CW4541B | BA1AP10CW4541BC | | 45° | | |
| BA1AP10CW6041B | BA1AP10CW6041BC | | 60° | | |

YEDEK PARÇA / SPARE PARTS / REPUESTOS

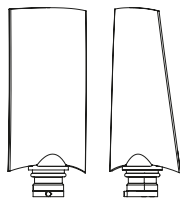

| KOD CODE - CÓDIGO | L | Yön Direction Dirección | Renk Color |
|----------------------|--------|-------------------------------|----------------------------|
| 08101218CW41T | 325 mm | Sol - Left | Turuncu - Orange - Naranja |
| 08101218CW41S | | Izquierda | Siyah - Black - Negro |



Balatalı Flanş
Flange With Clutch
Brida Con Embrague

08101300



8

**TORNADO 250 ALÜMİNYUM
PERVANE / 8 KANAT**

- Alüminyum Gövde ve Yüksek Dayanımlı Plastik Kanatlar
- 30° / 45° / 60° Açı Seçenekleri
- Pervane Dönüş Yönü: Sol - Sağ
- Traktör Güç Aralığı 55 - 95 Beygir

| | |
|--------------|--------------------|
| Pervane Çapı | 32" |
| Kanat Tipi | Tip 2 Eğimli Kanat |
| Göbek Çapı | 250 mm |

**TORNADO 250
ALUMINIUM HUB FAN**

- Aluminium Hub and Glass Reinforced Polyamide Blades
- 30° / 45° / 60° Pitch Angle Options
- Rotation Direction: Counterclockwise - Clockwise
- Tractor Power Range 55 - 95 HP



| | |
|--------------|--------|
| Diameter | 32" |
| Blade Type | Type 2 |
| Hub Diameter | 250 mm |

**TORNADO 250 VENTILADOR
CON NÚCLEO DE ALUMINIO**

- Núcleo de aluminio y aletas de polimida reforzada con fibra de vidrio
- Opciones de ángulos 30° / 45° / 60°
- La dirección de giro: Izquierda - Derecha
- La potencia máxima del tractor 55 - 95 HP

| | |
|--------------------|--------|
| Diámetro | 32" |
| Tipo de Aletas | Tipo 2 |
| Diámetro de Núcleo | 250 mm |

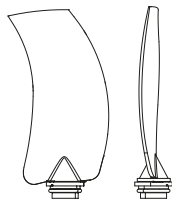

| KOD CODE - CÓDIGO | D | Açı Angle Ángulo | Yön Direction Dirección | Renk Color | |
|----------------------|-----|---|---|---|-------------------------|
| KA2AP08CW3032T | 32" |  30° | Sol Left Izquierda | Turuncu Orange Naranja | |
| KA2AP08CW4532T | |  45° | | | |
| KA2AP08CW6032T | |  60° | | | |
| KA2AP08CW3032S | |  30° | | Sarı Yellow Amarillo | |
| KA2AP08CW4532S | |  45° | | | |
| KA2AP08CW6032S | |  60° | | | |
| KA2AP08CW3032K | |  30° | | Kırmızı Red Rojo | |
| KA2AP08CW4532K | |  45° | | | |
| KA2AP08CW6032K | |  60° | | | |
| KA2AP08C3032T | | 32" | |  30° | Sağ Right Derecha |
| KA2AP08C4532T | | |  45° | | |
| KA2AP08C6032T | | |  60° | | |
| KA2AP08C3032S | | |  30° | Sarı Yellow Amarillo | |
| KA2AP08C4532S | | |  45° | | |
| KA2AP08C6032S | | |  60° | | |
| KA2AP08C3032K | | |  30° | Kırmızı Red Rojo | |
| KA2AP08C4532K | | |  45° | | |
| KA2AP08C6032K | | |  60° | | |

YEDEK PARÇA / SPARE PARTS / REPUESTOS

| KOD CODE - CÓDIGO | L | Yön Direction Dirección | Renk Color |
|----------------------|--------|-------------------------------|----------------------------|
| 08101211CW32T | 280 mm | Sol Left Izquierda | Turuncu - Orange - Naranja |
| 08101211CW32S | | | Sarı - Yellow - Amarillo |
| 08101211CW32K | | | Kırmızı - Red - Rojo |
| 08101211C32T | | Sağ Right Derecha | Turuncu - Orange - Naranja |
| 08101211C32S | | | Sarı - Yellow - Amarillo |
| 08101211C32K | | | Kırmızı - Red - Rojo |



TORNADO 330 ALÜMİNYUM PERVANE

- Alüminyum Gövde ve Yüksek Dayanımlı Plastik Kanatlar
- 30° / 45° / 60° Açı Seçenekleri
- Pervane Dönüş Yönü: Sol - Sağ
- Traktör Güç Aralığı 55 - 95 Beygir

| | |
|--------------|--------------------|
| Pervane Çapı | 36" |
| Kanat Tipi | Tip 2 Eğimli Kanat |
| Göbek Çapı | 330 mm |

TORNADO 330 ALUMINIUM HUB FAN

- Aluminium Hub and Glass Reinforced Polyamide Blades
- 30° / 45° / 60° Pitch Angle Options
- Rotation Direction: Counterclockwise - Clockwise
- Tractor Power Range 55 - 95 HP

| | |
|--------------|--------|
| Diameter | 36" |
| Blade Type | Type 2 |
| Hub Diameter | 330 mm |

TORNADO 330 VENTILADOR CON NÚCLEO DE ALUMINIO

- Núcleo de aluminio y aletas de polimada reforzada con fibra de vidrio
- Opciones de ángulos 30° / 45° / 60°
- La dirección de giro: Izquierda - Derecha
- La potencia máxima del tractor 55 - 95 HP

| | |
|--------------------|--------|
| Diámetro | 36" |
| Tipo de Aletas | Tipo 2 |
| Diámetro de Núcleo | 330 mm |



| KOD CODE - CÓDIGO | Balatalı - With Clutch Con Embrague | D | Açı Angle Ángulo | Yön Direction Dirección | Renk Color | |
|----------------------|--|-----|------------------------|-------------------------------|------------------------------|------------------------------|
| BA2AP10CW3036T | BA2AP10CW3036TC | 36" | 30° | Sol Left Izquierda | Turuncu Orange Naranja | |
| BA2AP10CW4536T | BA2AP10CW4536TC | | 45° | | | |
| BA2AP10CW6036T | BA2AP10CW6036TC | | 60° | | | |
| BA2AP10CW3036S | BA2AP10CW3036SC | | 30° | | Sağ Right Derecha | Sarı Yellow Amarillo |
| BA2AP10CW4536S | BA2AP10CW4536SC | | 45° | | | |
| BA2AP10CW6036S | BA2AP10CW6036SC | | 60° | | | |
| BA2AP10CW3036R | BA2AP10CW3036RC | | 30° | | Kırmızı Red Rojo | |
| BA2AP10CW4536R | BA2AP10CW4536RC | | 45° | | | |
| BA2AP10CW6036R | BA2AP10CW6036RC | | 60° | | | |
| BA2AP10C3036T | BA2AP10C3036TC | | 36" | 30° | Sağ Right Derecha | Turuncu Orange Naranja |
| BA2AP10C4536T | BA2AP10C4536TC | | | 45° | | |
| BA2AP10C6036T | BA2AP10C6036TC | | | 60° | | |
| BA2AP10C3036S | BA2AP10C3036SC | | | 30° | Sağ Right Derecha | Sarı Yellow Amarillo |
| BA2AP10C4536S | BA2AP10C4536SC | | | 45° | | |
| BA2AP10C6036S | BA2AP10C6036SC | | | 60° | | |
| BA2AP10C3036R | BA2AP10C3036RC | | | 30° | Kırmızı Red Rojo | |
| BA2AP10C4536R | BA2AP10C4536RC | | | 45° | | |
| BA2AP10C6036R | BA2AP10C6036RC | | | 60° | | |

YEDEK PARÇA / SPARE PARTS / REPUESTOS

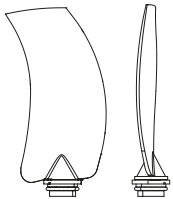

| KOD CODE - CÓDIGO | L | Yön Direction Dirección | Renk Color |
|----------------------|--------|-------------------------------|----------------------------|
| 08101215CW32T | 280 mm | Sol Left Izquierda | Turuncu - Orange - Turuncu |
| 08101215CW32S | | | Sarı - Yellow - Amarillo |
| 08101215CW32K | | | Kırmızı - Red - Rojo |
| 08101215C32T | | Sağ Right Derecha | Turuncu - Orange - Turuncu |
| 08101215C32S | | | Sarı - Yellow - Amarillo |
| 08101215C32K | | | Kırmızı - Red - Rojo |



Balatalı Flanş
Flange With Clutch
Brida Con Embrague

08101300



8

DRAGON 330 ALÜMİNYUM PERVANE HELİS

- Alüminyum Gövde ve Yüksek Dayanımlı Plastik Kanatlar
- 45° / 60° / 75° Açı Seçenekleri
- Pervane Dönüş Yönü: Sol
- Traktör Güç Aralığı 55 - 95 Beygir

| | |
|--------------|-------------------|
| Pervane Çapı | 36" |
| Kanat Tipi | Tip 3 Helis Kanat |
| Göbek Çapı | 330 mm |

DRAGON 330 ALUMINIUM HUB FAN

- Aluminium Hub and Glass Reinforced Polyamide Blades
- 45° / 60° / 75° Pitch Angle Options
- Rotation Direction: Counterclockwise
- Tractor Power Range 55 - 95 HP

| | |
|--------------|--------|
| Diameter | 36" |
| Blade Type | Type 3 |
| Hub Diameter | 330 mm |

DRAGON 330 VENTILADOR CON NÚCLEO DE ALUMINIO

- Núcleo de aluminio y aletas de polimida reforzada con fibra de vidrio
- Opciones de ángulos 45° / 60° / 75°
- La dirección de giro: Izquierda
- La potencia máxima del tractor 55 - 95 HP

| | |
|--------------------|--------|
| Diámetro | 36" |
| Tipo de Aletas | Tipo 3 |
| Diámetro de Núcleo | 330 mm |



| KOD CODE - CÓDIGO | Balatalı - With Clutch Con Embrague | D | Açı Angle Ángulo | Yön Direction Dirección | Renk Color |
|----------------------|--|-----|------------------------|-------------------------------|---------------|
| BA3AP10CW4536K | BA3AP10CW4536KC | 36" | 45° | Sol | Kırmızı |
| BA3AP10CW6036K | BA3AP10CW6036KC | | 60° | Left | Red |
| BA3AP10CW7536K | BA3AP10CW7536KC | | 75° | Izquierda | Rojo |

YEDEK PARÇA / SPARE PARTS / REPUESTOS

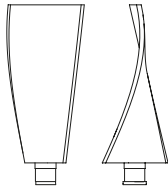

| KOD CODE - CÓDIGO | L | Yön Direction Dirección | Renk Color |
|----------------------|--------|-------------------------------|-----------------------|
| 08101212CW32 | 285 mm | Sol - Left Izquierda | Kırmızı Red - Rojo |



Balatalı Flanş
Flange With Clutch
Brida Con Embrague

08101300



POYRAZ ALÜMİNYUM PERVANE / 12 KANAT

- Alüminyum Gövde ve Yüksek Dayanımlı Plastik Kanatlar
- 30° / 45° / 60° Açı Seçenekleri
- Pervane Dönüş Yönü: Sol
- Traktör Güç Aralığı 55 - 95 Beygir

| | |
|--------------|----------|
| Pervane Çapı | 32", 36" |
| Kanat Tipi | Tip 5 |
| Göbek Çapı | 280 mm |

POYRAZ ALUMINIUM HUB FAN

- Aluminium Hub and Glass Reinforced Polyamide Blades
- 30° / 45° / 60° Pitch Angle Options
- Rotation Direction: Counterclockwise
- Tractor Power Range 55 - 95 HP

| | |
|--------------|----------|
| Diameter | 32", 36" |
| Blade Type | Type 5 |
| Hub Diameter | 280 mm |

POYRAZ VENTILADOR CON NÚCLEO DE ALUMINIO

- Núcleo de aluminio y aletas de polimada reforzada con fibra de vidrio
- Opciones de ángulos 30° / 45° / 60°
- La dirección de giro: Izquierda
- La potencia máxima del tractor 55 - 95 HP

| | |
|--------------------|----------|
| Diámetro | 32", 36" |
| Tipo de Aletas | Tipo 5 |
| Diámetro de Núcleo | 280 mm |



| KOD CODE - CÓDIGO | D | Açı Angle Ángulo | Yön Direction Dirección | Renk Color |
|----------------------|-----|------------------------|-------------------------------|-------------------------|
| BA5AP12CW3032M | 32" | 30° | Sol Left Izquierda | Mavi Blue Azul |
| BA5AP12CW4532M | | 45° | | |
| BA5AP12CW6032M | | 60° | | |
| BA5AP12CW3036M | 36" | 30° | | |
| BA5AP12CW4536M | | 45° | | |
| BA5AP12CW6036M | | 60° | | |
| BA5AP12CW3032Y | 32" | 30° | Sol Left Izquierda | Yeşil Green Verde |
| BA5AP12CW4532Y | | 45° | | |
| BA5AP12CW6032Y | | 60° | | |
| BA5AP12CW3036Y | 36" | 30° | | |
| BA5AP12CW4536Y | | 45° | | |
| BA5AP12CW6036Y | | 60° | | |

YEDEK PARÇA / SPARE PARTS / REPUESTOS

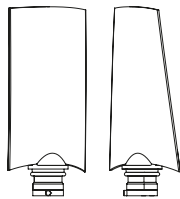

| KOD CODE - CÓDIGO | L | Yön Direction Dirección | Renk Color |
|----------------------|--------|-------------------------------|---------------------|
| 08101216CW32M | 290 mm | Sol - Left Izquierda | Mavi Blue - Azul |
| 08101216CW36M | 325 mm | | |



Flaş
Flange
Brida

08110021

Pervanelerimiz min. Ø 700 mm - Max. Ø 915 mm çaplarına kadar mevcuttur. Diğer renk ve ölçü seçenekleri için lütfen firmamız ile irtibata geçiniz.
Available dimensions between Ø 700 mm - Ø 915 mm. Please contact with us for other colour and size options.
Disponibles las dimensiones entre min. Ø 700 mm - max. Ø 915 mm. Póngase en contacto con nuestra empresa para otras opciones de color y tamaño.



8

FLANŞ (K230)

- Tip: İşlenmemiş
- Flanş Malzemesi: Döküm
- Göbek Tipi: Plastik
- Pervane Tipi: Bora 230 / Tayfun 230

**FLANGE**

- Type: Not Machined
- Flange Material: Cast Iron
- Hub Type: Plastic
- Fan Type: Bora 230 / Tayfun 230

KOD - CODE - CÓDIGO

08110002

BRIDA

- Tipo: No mecanizado
- Material: Hierro fundido
- Tipo de Núcleo: Plástico
- Tipo de Ventilador: Bora 230 / Tayfun 230

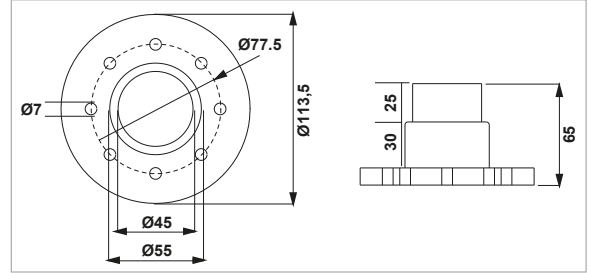
**FLANŞ (B300)**

- Tip: İşlenmemiş
- Flanş Malzemesi: Döküm / Alüminyum
- Göbek Tipi: Plastik
- Pervane Tipi: Bora 300 / Tayfun 300
Dragon 330

**FLANGE**

- Type: Not Machined
- Flange Material: Cast Iron / Aluminium
- Hub Type: Plastic
- Fan Type: Bora 300 / Tayfun 300
Dragon 330

KOD - CODE - CÓDIGO

08110003

08110003AL

BRIDA

- Tipo: No mecanizado
- Material: Hierro fundido / Aluminio
- Tipo de Núcleo: Plástico
- Tipo de Ventilador: Bora 300 / Tayfun 300
Dragon 330

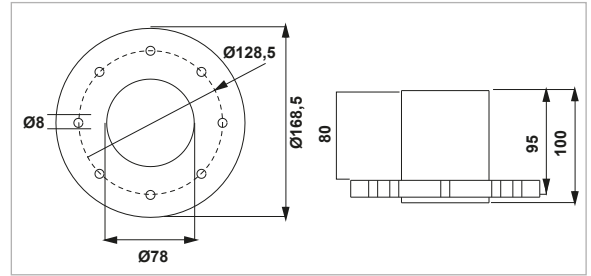
**FLANŞ (260)**

- Tip: İşlenmemiş
- Flanş Malzemesi: Döküm
- Göbek Tipi: Plastik
- Pervane Tipi: Dragon 260

**FLANGE**

- Type: Not Machined
- Flange Material: Cast Iron
- Hub Type: Plastic
- Fan Type: Dragon 260

KOD - CODE - CÓDIGO

08110004

BRIDA

- Tipo: No mecanizado
- Material: Hierro fundido
- Tipo de Núcleo: Plástico
- Tipo de Ventilador: Dragon 260

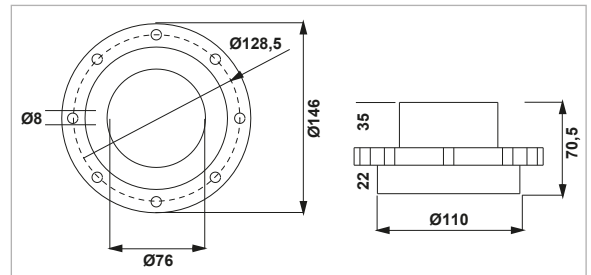
**FLANŞ (KISA - 250)**

- Tip: İşlenmemiş
- Flanş Malzemesi: Alüminyum
- Göbek Tipi: Alüminyum
- Pervane Tipi: Anemos 250 / Vento 250
Tornado 250

**FLANGE**

- Type: Not Machined
- Flange Material: Aluminium
- Hub Type: Aluminium
- Fan Type: Anemos 250 / Vento 250
Tornado 250

KOD - CODE - CÓDIGO

08110010

BRIDA

- Tipo: No mecanizado
- Material: Aluminio
- Tipo de Núcleo: Aluminio
- Tipo de Ventilador: Anemos 250 / Vento 250
Tornado 250

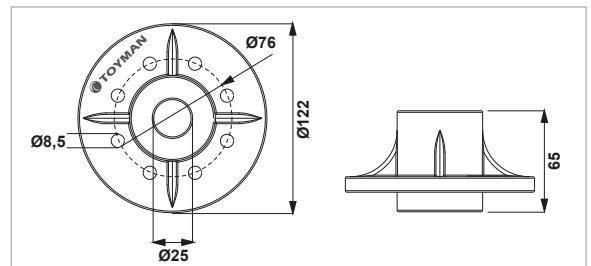

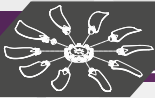
**8****FLANŞ (UZUN - 250)**

- Tip: İşlenmemiş
- Flanş Malzemesi: Alüminyum
- Göbek Tipi: Alüminyum
- Pervane Tipi: Anemos 250 / Vento 250 Tornado 250

**FLANGE**

- Type: Not Machined
- Flange Material: Aluminium
- Hub Type: Aluminium
- Fan Type: Anemos 250 / Vento 250 Tornado 250

KOD - CODE - CÓDIGO

08110011**BRIDA**

- Tipo: No mecanizado
- Material: Aluminio
- Tipo de Núcleo: Aluminio
- Tipo de Ventilador: Anemos 250 / Vento 250 Tornado 250

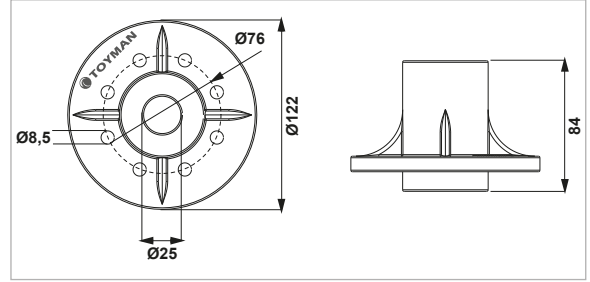
**FLANŞ (DÜZ KISA - İ250)**

- Tip: İşlenmiş
- Flanş Malzemesi: Alüminyum
- Göbek Tipi: Alüminyum
- Pervane Tipi: Anemos 250 / Vento 250 Tornado 250
- Şanzıman Tipi: Comer D27 9.727.386 (Düz - Kısa)

**FLANGE**

- Type: Machined
- Flange Material: Aluminium
- Hub Type: Aluminium
- Fan Type: Anemos 250 / Vento 250 Tornado 250
- Gear Box: Comer D27 9.727.386

KOD - CODE - CÓDIGO

08110007**BRIDA**

- Tipo: Mecanizado
- Material: Aluminio
- Tipo de Núcleo: Aluminio
- Tipo de Ventilador: Anemos 250 / Vento 250 Tornado 250
- Caja de engranaje: Comer D27 9.727.386

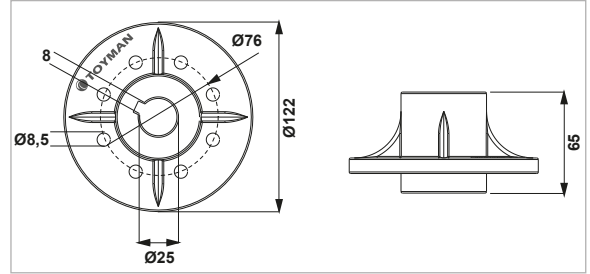
**FLANŞ (DÜZ UZUN - İ250)**

- Tip: İşlenmiş
- Flanş Malzemesi: Alüminyum
- Göbek Tipi: Alüminyum
- Pervane Tipi: Anemos 250 / Vento 250 Tornado 250
- Şanzıman Tipi: Comer D27 9.727.390 (Düz - Uzun)

**FLANGE**

- Type: Machined
- Flange Material: Aluminium
- Hub Type: Aluminium
- Fan Type: Anemos 250 / Vento 250 Tornado 250
- Gear Box: Comer D27 9.727.390

KOD - CODE - CÓDIGO

08110008**BRIDA**

- Tipo: Mecanizado
- Material: Aluminio
- Tipo de Núcleo: Aluminio
- Tipo de Ventilador: Anemos 250 / Vento 250 Tornado 250
- Caja de engranaje: Comer D27 9.727.390

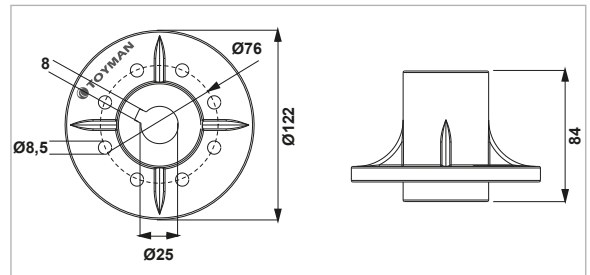
**FLANŞ (KONİK - İ250)**

- Tip: İşlenmiş
- Flanş Malzemesi: Alüminyum
- Göbek Tipi: Alüminyum
- Pervane Tipi: Anemos 250 / Vento 250 Tornado 250
- Şanzıman Tipi: Comer D27 9.727.00030 (Konik Uzun)

**FLANGE**

- Type: Machined
- Flange Material: Aluminium
- Hub Type: Aluminium
- Fan Type: Anemos 250 / Vento 250 Tornado 250
- Gear Box: Comer D27 9.727.00030

KOD - CODE - CÓDIGO

08110009**BRIDA**

- Tipo: Mecanizado
- Material: Aluminio
- Tipo de Núcleo: Aluminio
- Tipo de Ventilador: Anemos 250 / Vento 250 Tornado 250
- Caja de engranaje: Comer D27 9.727.00030

